



HINKLEY

FAN CATALOG 2022

HINKLEY

THIS CATALOG INCLUDES ALL FANS AND ACCESSORIES.
FOR A COMPLETE PRODUCT OFFERING, VISIT [HINKLEY.COM](https://www.hinkley.com).

HINKLEY, INC. | 2022

HINKLEY
100

1922 - 2022

A CENTURY OF STYLE





“A heritage infused with creativity, perseverance, and optimism inspires our future vision: designing innovative products that blend the best of classic and cool, technology and tradition.”

JESS WIEDEMER + ERIC WIEDEMER

What's always been most important to us is listening to our customers and delivering Hinkley style and quality in new and thrilling ways. As the 4th generation of Hinkley's family-owned business, our legacy is firmly built on resilience and a genuine rapport with true home enthusiasts.

This new era represents what has motivated Hinkley throughout every decade of the past 100 years: a passion for the home, thoughtful design, and a commitment to growth.

Cheers to the next century of style!



Jess Wiedemer,
President



Eric Wiedemer,
VP & General Counsel

HI THERE, WE'RE HINKLEY

Welcome to the *family*

We're here to make your research process a snap, with our newest designs, featured collections, in-depth product details, curated styles, and endless inspiration throughout these pages and at hinkley.com.

Our easy-to-use site will guide you through every ceiling fan and lighting decision. We deliver the most helpful product features, specs and tips at-a-glance for every project, as well as a quick connection to our elite network of retailers.

Once you've welcomed Hinkley into your home, stay connected with us. We know that sometimes things happen, and we want to answer any questions as quickly as possible.

Just head to hinkley.com/register: we're always here if you have a question, need some help, or want to chat about our products.

Discover designs to deck out your space

INSPIRATION AWAITS

Just like you, we've reconnected with our homes and appreciate more than ever how important these interior and exterior spaces are to our health, happiness and well-being.

We love seeing how you live and sharing ideas and inspiration with each other. Stay in the loop on all Hinkley happenings, from your favorite styles, the best (seriously) giveaways, helpful tips, our latest collabs, Team Hinkley hilarity, and brand new design drops [@hinkleylighting](https://twitter.com/hinkleylighting)



#hinkleystyle



TABLE OF CONTENTS



PG. 26 ▲

ON THE COVER:
MERRICK 900360FHB-LDD



PG. 102 ▲

FANDELIER FANDOM

SAY HELLO TO HIRO	14
SMART FAN	19
FAN FACTS	21
SELECTING A CEILING FAN	24
FANS	26
FANDELIERS	104
REGENCY SERIES	113
LIGHT KITS + ACCESSORIES	144
CONTROLS	148
INDEX	150

FANS

60" ARTISTE	82	60" MARIN	32
72" ARTISTE	84	60" MERRICK	26
60" BIMINI	90	60" SCULPT	50
44" CHISEL	54	80" SCULPT	52
52" CHISEL	56	60" SWELL	60
60" CHISEL	58	80" SWELL	62
54" COLLIER	36	60" SWELL FLUSH	64
56" HAMPTON	34	54" TIER	86
52" HOVER	66	44" TREY	92
60" HOVER	68	52" TREY	94
52" HOVER FLUSH	70	52" TROPIC AIR	100
60" HOVER FLUSH	72	60" TURBINE	28
72" HOVER FLUSH	74	80" TURBINE	30
56" INDY	38	52" VAIL	78
72" INDY	40	52" VAIL FLUSH	80
58" INDY FLUSH	42	66" VANTAGE	76
72" INDY FLUSH	44	44" VENTUS	96
82" INDY MAXX	46	52" VENTUS	98
99" INDY MAXX	48	52" VERGE	88

FANDELIERS

27" BRYCE	104	30" FINNIGAN	109
22" ELI	106	36" SAWYER	110
24" FINNIGAN	108		

REGENCY SERIES

52" AFTON	120	60" HIGHLAND	132
36" CABANA	136	60" HIGHLAND WET	134
42" CROFT	114	52" METRO	140
52" CROFT	116	52" METRO ILLUMINATED	138
60" CROFT	118	52" METRO WET	142
52" HIGHLAND	128	52" OASIS	122
52" HIGHLAND ILLUMINATED	126	60" OASIS	124
52" HIGHLAND WET	130		

ICONS + FINISH REFERENCES

Every Hinkley product is thoughtfully designed and carefully crafted with important features, so we've created useful icons and finish codes to help you with your lighting selections.

Below is a key describing each of these icons in detail as well as a list of our extensive product finishes with abbreviated codes for easy reference.

ICON DESCRIPTIONS



DAMP

Suitable for use in damp (interior moist and outdoor no direct rain or sprinkler) locations as defined by NEC and CEC. Meets United States UL Underwriters Laboratories & CSA Canadian Standards Association Product Safety Standards.



DC MOTOR

Fan comes equipped with a DC motor which uses up to 70% less energy than an AC motor and runs cooler and quieter for a longer life.



ETL LISTED

Fan has been tested by Intertek and found in compliance with accepted national safety standards.



HIRO CONTROL

All-in-one wireless remote and wall control combines flexible operation for fan speed and light control with ease of installation for multiple configurations.



LED

Fan supplied with fully integrated LEDs and drivers or specifically matched LED lamps based on performance and application.



REGENCY SERIES

Fan is a Regency Series design, offering affordable, all-purpose styles.



TITLE 24

Meets California Energy Commission Title regulations.



UL LISTED

Fan has been tested by Underwriters Laboratories and found in compliance with accepted national safety standards.



WET

Suitable for use in wet (interior direct splash and outdoor direct rain or sprinkler) locations as defined by NEC and CEC. Meets United States UL Underwriters Laboratories & CSA Canadian Standards Association Product Safety Standards.



WiFi

Fan is WiFi compatible.

FINISH CODES + NAMES

FAW	APPLIANCE WHITE
FBN	BRUSHED NICKEL
FCW	CHALK WHITE
FGT	GRAPHITE
FHB	HERITAGE BRASS
FMB	MATTE BLACK
FMW	MATTE WHITE
FMM	METALLIC MATTE BRONZE
FPW	PEWTER
FSS	SATIN STEEL

PICTORIAL INDEX



60" ARTISTE
900160
 Page 82
 Brushed Nickel, Graphite,
 Metallic Matte Bronze, Matte White



72" ARTISTE
900172
 Page 84
 Brushed Nickel, Graphite,
 Metallic Matte Bronze, Matte White



60" BIMINI
900260
 Page 90
 Appliance White, Brushed Nickel,
 Metallic Matte Bronze

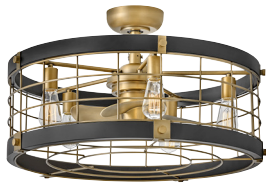

27" BRYCE
904627
 Page 104
 Brushed Nickel,
 Heritage Brass, Matte Black



44" CHISEL
903744
 Page 54
 Graphite, Matte Black,
 Matte White



52" CHISEL
903752
 Page 56
 Graphite, Matte Black,
 Matte White



60" CHISEL
903760
 Page 58
 Graphite, Matte Black,
 Matte White



54" COLLIER
903254
 Page 36
 Heritage Brass, Matte Black,
 Metallic Matte Bronze, Pewter



22" ELI
905022
 Page 106
 Brushed Nickel,
 Heritage Brass, Matte Black



24" FINNIGAN
904724
 Page 108
 Matte Black



30" FINNIGAN
904730
 Page 109
 Matte Black



56" HAMPTON
903056
 Page 34
 Brushed Nickel, Heritage Brass,
 Metallic Matte Bronze



PICTORIAL INDEX



52" HOVER
900752
 Page 66
 Brushed Nickel,
 Graphite, Matte Black,
 Matte White, Matte White (KOA)
 DC ♻️ T24 📶 HIRO



60" HOVER
900760
 Page 68
 Brushed Nickel,
 Graphite, Matte Black,
 Matte White, Matte White (KOA)
 DC ♻️ T24 📶 HIRO



52" HOVER FLUSH
900852
 Page 70
 Brushed Nickel, Graphite,
 Matte Black, Matte White
 DC ♻️ T24 📶 HIRO



60" HOVER FLUSH
900860
 Page 72
 Brushed Nickel, Graphite,
 Matte Black, Matte White
 DC ♻️ T24 📶 HIRO



72" HOVER FLUSH
900872
 Page 74
 Brushed Nickel,
 Graphite, Matte Black,
 Metallic Matte Bronze, Matte White
 DC ♻️ T24 📶 HIRO



56" INDY
900956
 Page 38
 Brushed Nickel, Matte Black,
 Metallic Matte Bronze, Matte White
 ♻️



72" INDY
900972
 Page 40
 Brushed Nickel, Matte Black,
 Metallic Matte Bronze, Matte White
 ♻️



58" INDY FLUSH
901058
 Page 42
 Brushed Nickel, Matte Black,
 Metallic Matte Bronze, Matte White
 DC ♻️ 📶 HIRO



72" INDY FLUSH
901072
 Page 44
 Brushed Nickel, Matte Black,
 Metallic Matte Bronze, Matte White
 DC ♻️ 📶 HIRO



82" INDY MAXX
900982
 Page 46
 Brushed Nickel, Matte Black,
 Metallic Matte Bronze, Matte White
 DC ♻️ T24 📶 HIRO



99" INDY MAXX
900999
 Page 48
 Brushed Nickel, Matte Black,
 Metallic Matte Bronze, Matte White
 DC ♻️ T24 📶 HIRO



60" MARIN
903160
 Page 32
 Matte Black, Metallic Matte Bronze,
 Matte White
 DC ♻️ T24 📶 HIRO

PICTORIAL INDEX



60" MERRICK
900360
 Page 26
 Heritage Brass, Metallic Matte Bronze, Matte White



36" SAWYER
902928
 Page 110
 Matte Black, Matte White, Metallic Matte Bronze



60" SCULPT
903660
 Page 50
 Graphite, Matte Black



80" SCULPT
903680
 Page 52
 Graphite, Matte Black



60" SWELL
903860
 Page 60
 Graphite, Matte Black



80" SWELL
903880
 Page 62
 Graphite, Matte Black



60" SWELL FLUSH
903460
 Page 64
 Matte Black, Metallic Matte Bronze, Matte White



54" TIER
902054
 Page 86
 Appliance White, Brushed Nickel, Matte Black, Metallic Matte Bronze



44" TREY
902744
 Page 92
 Brushed Nickel, Metallic Matte Bronze, Matte White



52" TREY
902752
 Page 94
 Brushed Nickel, Metallic Matte Bronze, Matte White



52" TROPIC AIR
901952
 Page 100
 Graphite, Matte Black, Metallic Matte Bronze, Matte White



60" TURBINE
904260
 Page 28
 Chalk White, Matte Black, Metallic Matte Bronze



PICTORIAL INDEX



80" TURBINE
904280
 Page 30
 Chalk White, Matte Black,
 Metallic Matte Bronze



52" VAIL
902152
 Page 78
 Brushed Nickel, Graphite,
 Matte Black, Metallic Matte Bronze,
 Matte White



52" VAIL FLUSH
902552
 Page 80
 Brushed Nickel, Graphite,
 Matte Black, Metallic Matte Bronze,
 Matte White



66" VANTAGE
902466
 Page 76
 Brushed Nickel, Graphite,
 Matte Black, Metallic Matte Bronze,
 Matte White



44" VENTUS
902844
 Page 96
 Metallic Matte Bronze,
 Matte White, Pewter



52" VENTUS
902852
 Page 98
 Metallic Matte Bronze,
 Matte White, Pewter



52" VERGE
902352
 Page 88
 Brushed Nickel, Matte Black,
 Metallic Matte Bronze, Matte White



52" AFTON
903552
 Page 120
 Chalk White, Matte Black,
 Metallic Matte Bronze,
 Satin Steel



36" CABANA
901836
 Page 136
 Appliance White, Brushed Nickel,
 Matte Black, Metallic Matte Bronze



42" CROFT
904042
 Page 114
 Brushed Nickel, Chalk White,
 Matte Black, Metallic Matte Bronze



52" CROFT
904052
 Page 116
 Brushed Nickel, Chalk White,
 Heritage Brass, Matte Black,
 Metallic Matte Bronze



PICTORIAL INDEX



60" CROFT
904060
 Page 118
 Brushed Nickel, Chalk White, Matte Black, Metallic Matte Bronze



52" HIGHLAND
904152
 Page 128
 Brushed Nickel, Chalk White, Matte Black, Metallic Matte Bronze



52" HIGHLAND ILLUMINATED
904152
 Page 126
 Brushed Nickel, Chalk White, Matte Black, Metallic Matte Bronze



52" HIGHLAND WET
904152
 Page 130
 Brushed Nickel, Chalk White, Matte Black, Metallic Matte Bronze



60" HIGHLAND
904160
 Page 132
 Brushed Nickel, Chalk White, Matte Black, Metallic Matte Bronze



60" HIGHLAND WET
904160
 Page 134
 Brushed Nickel, Chalk White, Matte Black, Metallic Matte Bronze



52" METRO
903352
 Page 140
 Brushed Nickel, Chalk White, Matte Black, Metallic Matte Bronze



52" METRO ILLUMINATED
903352
 Page 138
 Brushed Nickel, Chalk White, Matte Black, Metallic Matte Bronze



52" METRO WET
903352
 Page 142
 Brushed Nickel, Chalk White, Matte Black, Metallic Matte Bronze



52" OASIS
901652
 Page 122
 Brushed Nickel, Chalk White, Graphite, Matte Black, Metallic Matte Bronze



60" OASIS
901660
 Page 124
 Brushed Nickel, Chalk White, Graphite, Matte Black, Metallic Matte Bronze





HINKLEY FANS ARE GUARANTEED TO KEEP YOU COOL.

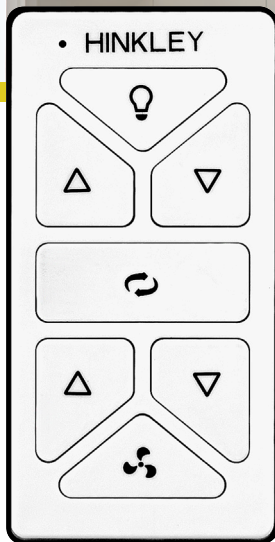

Say hello to...

HIRO

HINKLEY'S SMART FAN CONTROL SYSTEM

HIRO

A **HIGHLY INTELLIGENT** DESIGN FEATURING **REMOTE OPERATION**
FOR THE **ULTIMATE SMART HOME** CONNECTIVITY

HIRO's all-in-one wireless remote and wall control combines flexible operation for fan speed and light control with ease of installation for multiple configurations. Versatile and easy-to-use, HIRO requires no wires, is compatible with all Hinkley fans, and incorporates WiFi and highly-reliable RF technology – ensuring seamless communication between system components.

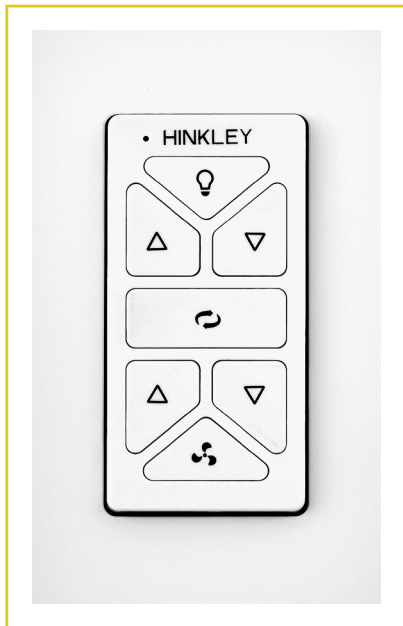

HIRO COMBINES FEATURES AND FUNCTIONALITY – A POSITIVE SPIN ON SMART FANS AND ACCESSORIES

- Includes a receiver with WiFi capability
- Configures for use as a **wall-mount control** or **handheld remote**
- Secures to a **flat wall** or a **single/multiple gang switch box**
- Nestles within a standard decorative opening face plate for a **contemporary** and **elegant aesthetic**
- Integrates with **other smart home products**, including voice assistants from Amazon and Google
- Operates with **existing receivers/controllers**. Additionally, existing wall and remote controls are compatible with the new WiFi controllers
- Features a **manual switch to turn off and on**, allowing for days when everything goes wrong – losing the remote or your WiFi is down

FLEXIBLE – FUNCTIONAL – COMPATIBLE

Hinkley's product development and engineering teams innovated every way to control a fan in the most **elegant, sophisticated** and **concise design** possible.

HIRO CONFIGURATIONS AND VERSATILITY

In a collective and collaborative world, the expertly engineered HIRO system adapts to all home environments.

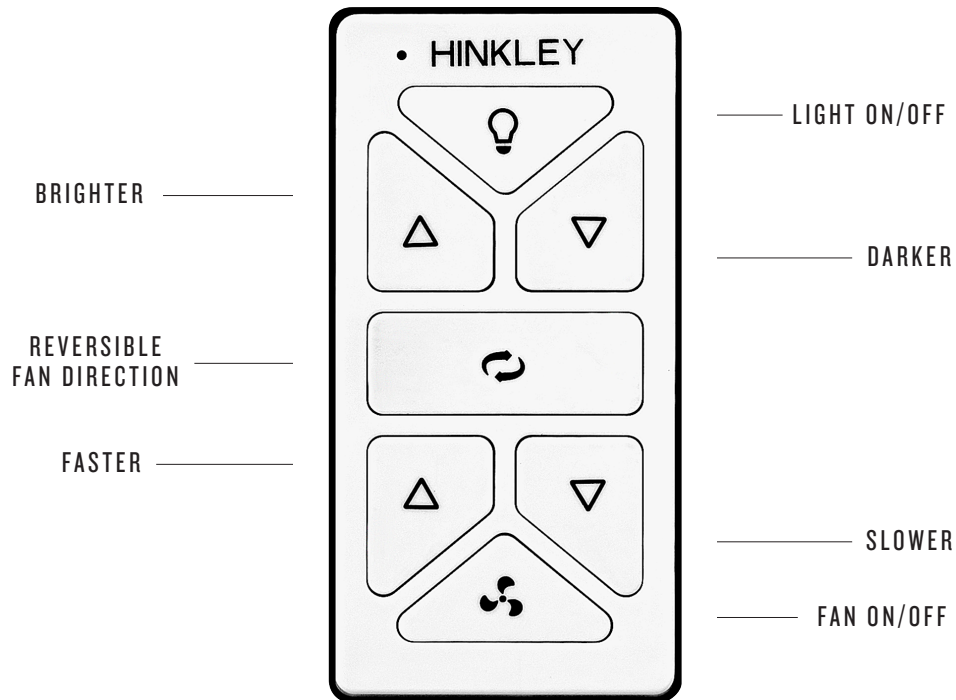

OPTIONS INCLUDED IN BOX:



**FACE PLATE
BRACKET**



**DECORATIVE
FACE PLATE**



**WALL
CRADLE**



**SWITCH
CRADLE**



**HIRO
REMOTE**

With the face plate, wall cradle, decorative style face plate, and remote transmitter, HIRO mounts on the wall without needing an electrician or additional wiring. HIRO is compatible with any decorator-style face plate and is easily retrofitted to any gang/receptacle location.

HIRO FITS ANYWHERE

The HIRO control is designed to work in any standard decorative style faceplate.



6-SPEED + 4-SPEED + 3-SPEED FANS

Whether using a remote, an app, or a wall control, the WiFi-enabled HIRO system from Hinkley is specifically designed to give the user full control when operating new or existing 6-speed, 4-speed, and 3-speed ceiling fans within the home.

6-SPEED DC MOTOR FANS

- HIRO all-in-one receiver supplied with fan where fan reverses at the control
- Wall/Remote Control included
- Included controllers are WiFi compatible

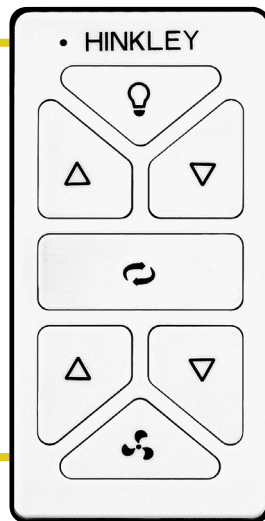

980014 FWH-R

3-SPEED AC + 4-SPEED DC MOTOR FANS

- HIRO all-in-one Wall/Remote Control included
- Manual Reverse located at the fan, not at the control
- Accessory controllers are WiFi compatible. (Sold Separately)

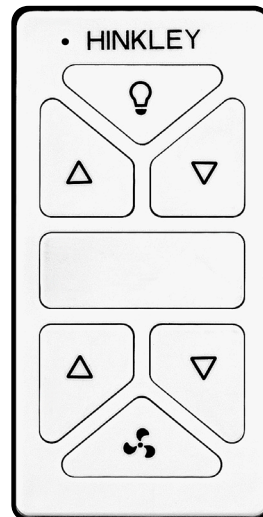

980014 FWH





YOUR SPACE JUST GOT SMARTER

WHY A HINKLEY WIFI ENABLED FAN IS THE WAY TO GO

Hinkley 6-speed DC fans are smart and ready for WiFi right out of the box. Hinkley 3 and 4-speed fans are WiFi adaptable with the purchase of an accessory control.

CHECK OUT THE BENEFITS OF GOING SMART:



Adding WiFi controls connect Hinkley fans to a home's digital environment.



Voice activation is a must for hands-free ease of use.



Speed, light and seasonal modes are just a tap away. From anywhere, anytime.



Make life seamless by setting schedules and preferences.

Add an optional WiFi control to any 3 or 4-speed Hinkley fan to make it a smart fan. Refer to **“Optional Controls”** on the product pages for compatible WiFi controls.



EVERY SOMEWHAT USEFUL FACT
YOU EVER WANTED TO KNOW ABOUT

HINKLEY

FANS

458

NEW FANS + ACCESSORIES

INCLUDING LIGHT KITS, CONTROLS AND INSTALLATION ACCESSORIES TO JAZZ UP THE LOOK AND USABILITY OF YOUR HINKLEY FAN

7

A HINKLEY FAN WILL MAKE YOU FEEL

DEGREES COOLER

THAN THE ACTUAL TEMPERATURE OF YOUR SURROUNDINGS

SEASONALLY APPROPRIATE



Cool off in the summer with blades heading in a



COUNTER-CLOCKWISE DIRECTION



Warm up in the winter with blades heading in a



CLOCKWISE DIRECTION

A HINKLEY FAN IS A GRAY T-SHIRT'S BEST FRIEND



your shirt without a Hinkley fan



your shirt with a Hinkley fan

1,624

THE # OF TIMES THE WORD "HIRO" HAS BEEN SAID + HEARD AT HINKLEY HQ



DID YOU KNOW THAT A

HINKLEY FAN

IS THE ONLY MONEY-SAVING APPLIANCE IN YOUR HOME? YEP, IT'S TRUE. USING A FAN CONTRIBUTES TO LOWER ENERGY COSTS

THE AVERAGE AMOUNT OF TIME A



WILL BE FULLY FASCINATED BY A HINKLEY FAN:

9

MINUTES



THE AWARD FOR CUTEST OVERALL FAN NAME + STYLE GOES TO THE

HUGGERS

AKA FLUSH MOUNT FANS—DOWNROD FREE AND GREAT FOR LOW CEILINGS



GET TO KNOW THE PIECES, PARTS AND PERFORMANCE ELEMENTS OF **HINKLEY FANS**

FAN DNA

FOR FAN NEWBIES AND AMBITIOUS PEOPLE WHO READ ALL OF THE INSTRUCTIONS BEFORE PUTTING STUFF TOGETHER

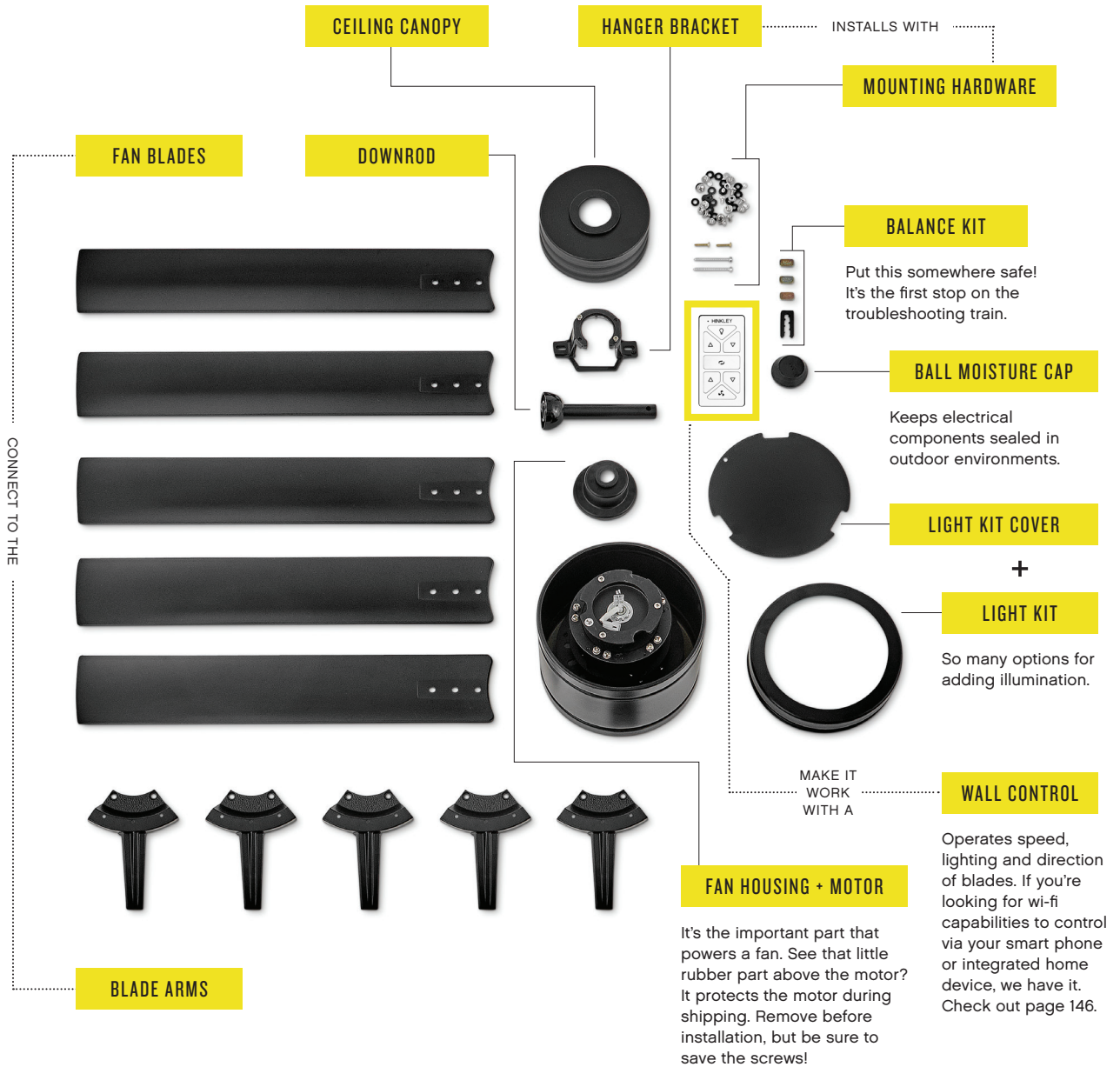

BANISH BUYING ANXIETY! MASTER THE MOST IMPORTANT FACTORS FOR

SELECTING A CEILING FAN

THE VERY FIRST THING TO CONSIDER IS...

1 Location

Inside? Outside? Under cover? Wet rated fans are a must in any area exposed to the elements. Spaces like covered porches and sunrooms are best served by outdoor fans when condensation and high humidity are factors. Wet rated fans can be used inside as well, but indoor-only fans can't play outside.

2 Style

Narrow your search by finding fans that complement your home's décor. Go for modern if a streamlined look is more your style or check out traditional fans if they best suit your space. From island-inspired to mid-century, Hinkley has a fan (with plenty of finish and blade options) to fit your vibe.

3 Size

Choosing the right size fan is important. A fan that is too large can overpower a room, and too small will not circulate enough air. These guidelines will help:

SQUARE FOOTAGE OF ROOM + BLADE SWEEP = PERFECT FAN RATIO



36-44"
BLADE SWEEP

< 100 SQUARE FEET



52-56"
BLADE SWEEP

100-150 SQUARE FEET



60-72"
BLADE SWEEP

> 150 SQUARE FEET

4 Airflow

UNDERSTANDING CFM:
CONVERTING ENERGY TO AIRFLOW

CFM is the magic acronym needed to achieve the optimum airflow output of a fan. It also calculates the operating cost and energy expenditure of your fan. So what actually is CFM?

THE VELOCITY OF AIRFLOW, MEASURED IN CUBIC FEET PER MINUTE	IF YOU WANT GREAT AIRFLOW, LOOK FOR A FAN WITH A CFM RATING OF 5,000 OR HIGHER.
MORE IS BETTER WHEN YOU'RE SPEAKING CEILING FAN CFM	

7 Motor

THERE ARE 2 TYPES OF FAN MOTORS:

AC Also known as a spinner motor fan.

DC Use up to 70% less energy than an AC motor fan. They run cooler and quieter for longer life!

5 Light

BECAUSE SOMETIMES YOU JUST NEED OVER-HEAD LIGHTING. LED LIGHT KITS ARE EITHER INCLUDED OR OFFERED AS OPTIONAL ACCESSORIES FOR ALL FANS.

6 Control

Fans now have far more options than pull chains to operate! Look for included or optional accessories to make your fan WiFi compatible for smart phone control and integrate with home devices like Alexa and Google Assistant for voice activation.

8 Customize

Fans are cool because you can customize both aesthetic and operational elements. If you are the kind of person who rearranges your furniture and swaps out throw pillows seasonally, look for fans with reversible blades. If creating a connected home is at the top of your to-do list, check out the many options for controls.



60" MERRICK™

Merrick blends aesthetic appeal and practicality. Its authentic leather accents add a touch of tradition, while its carefully crafted blades provide just the right balance of contemporary style. Available in a variety of finishes, Merrick is the perfect accent piece to all spaces.



900360FHB-LDD
HERITAGE BRASS WITH BROWN LEATHER
ACCENT WITH DRIFTWOOD BLADES

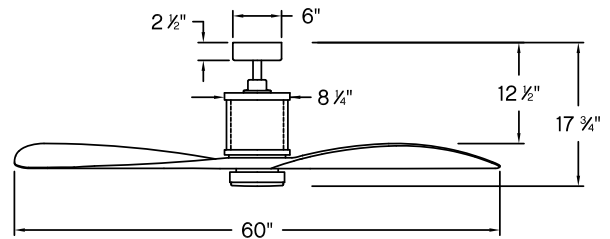

DESCRIPTION

900360FHB-LDD - HERITAGE BRASS

900360FMM-LDD - METALLIC MATTE BRONZE

900360FMW-LDD - MATTE WHITE

BLADES:

- 3 Composite Blades Included
- 20° Blade Pitch
- 60" Blade Sweep

MOUNTING:

- 6" Downrod Included
- 76" Lead Wire
- 21 lbs. Hanging Weight
- Mounts to Sloped Ceilings
 - Up to 23° Pitch

Slope ceiling kit required for ceiling pitch greater than 23°, 992001FXX, see page 146.

LAMPING/GLASS:

- 16w LED Included
- 1500 Lumens | 90 CRI | 3000K
- Dimmable
- Etched Opal Glass

INCLUDED CONTROLS:

980014FWH-R
6 Speed HIRO Reversing



- Includes WiFi Enabled Control



Light Kit Cover
Included with Fan



900360FMW-LDD
MATTE WHITE WITH TAN LEATHER
ACCENT WITH WEATHERED WOOD BLADES



900360FMM-LDD
METALLIC MATTE BRONZE FINISH BROWN
LEATHER ACCENT WITH DRIFTWOOD BLADES

PERFORMANCE SPECIFICATIONS	STANDARD	
	HIGH SPEED	AVG SPEED
AIRFLOW (CFM)	6339	4601
ENERGY USE (WATTS)	26.5	17
AIRFLOW EFFICIENCY (CFM/W)	239	273
ENERGY COSTS (YEARLY)	\$7.00	\$5.00
AMPS	0.36	0.21
RPMS	105	75

60" TURBINE™

Turbine is a robust nine-blade fan, offering a clean look and excellent breeze. Its sleek blades accentuate all spaces, available in a variety of finishes. Complemented by a beautiful etched opal glass, Turbine boasts modern functionality. Versatile in style and form, Turbine appeals to both interior and outdoor living spaces.



904260FCW-LWD
CHALK WHITE FINISH WITH
WEATHERED WOOD BLADES

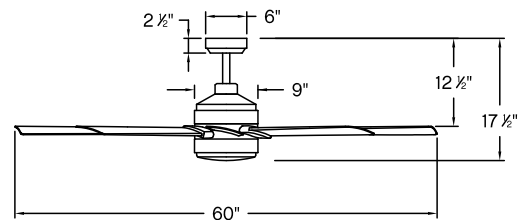

DESCRIPTION

904260FCW-LWD - CHALK WHITE

904260FMB-LWD - MATTE BLACK

904260FMM-LWD - METALLIC MATTE BRONZE

BLADES:

- 9 Composite Blades Included
- 13° Blade Pitch
- 60" Blade Sweep

MOUNTING:

- 6" Downrod Included
- 80" Lead Wire
- 31 lbs. Hanging Weight
- Mounts to Sloped Ceilings
- Up to 20° Pitch

Slope ceiling kit required for ceiling pitch greater than 20°, 992001FXX, see page 146.

LAMPING/GLASS:

- 24w LED Included
- 2400 Lumens | 90 CRI | 3000K
- Dimmable
- Etched Opal Glass

INCLUDED CONTROLS:

980014FWH-R
6 Speed HIRO Reversing



 Includes WiFi Enabled Control



Light Kit Cover
Included with Fan



904260FMB-LWD
MATTE BLACK WITH
DRIFTWOOD BLADES



904260FMM-LWD
METALLIC MATTE BRONZE
WITH WALNUT BLADES

PERFORMANCE SPECIFICATIONS	STANDARD	
	HIGH SPEED	AVG SPEED
AIRFLOW (CFM)	9147	6160
ENERGY USE (WATTS)	39	27
AIRFLOW EFFICIENCY (CFM/W)	235	232
ENERGY COSTS (YEARLY)	\$10.93	\$7.00
AMPS	0.51	0.29
RPMS	136	90

80" TURBINE™

Turbine is a robust nine-blade fan, offering a clean look and excellent breeze. Its sleek blades accentuate all spaces, available in a variety of finishes. Complemented by a beautiful etched opal glass, Turbine boasts modern functionality. Versatile in style and form, Turbine appeals to both interior and outdoor living spaces.



FMM-LWD
METALLIC MATTE BRONZE
WITH WALNUT BLADES

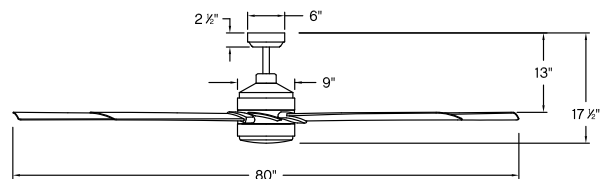

DESCRIPTION

904280FCW-LWD - CHALK WHITE

904280FMB-LWD - MATTE BLACK

904280FMM-LWD - METALLIC MATTE BRONZE

BLADES:

- 9 Composite Blades Included
- 13° Blade Pitch
- 80" Blade Sweep

MOUNTING:

- 6" Downrod Included
- 80" Lead Wire
- 38 lbs. Hanging Weight
- Mounts to Sloped Ceilings
- Up to 20° Pitch

Slope ceiling kit required for ceiling pitch greater than 20°, 992001FXX, see page 146.

LAMPING/GLASS:

- 24w LED Included
- 2400 Lumens | 90 CRI | 3000K
- Dimmable
- Etched Opal Glass

INCLUDED CONTROLS:

980014FWH-R
6 Speed HIRO Reversing



 Includes WiFi Enabled Control



Light Kit Cover
Included with Fan



904280FMB-LWD
MATTE BLACK FINISH WITH
DRIFTWOOD BLADES



904280FCW-LWD
CHALK WHITE FINISH WITH
WEATHERED WOOD BLADES

PERFORMANCE SPECIFICATIONS	STANDARD	
	HIGH SPEED	AVG SPEED
AIRFLOW (CFM)	12944	8634
ENERGY USE (WATTS)	36	26
AIRFLOW EFFICIENCY (CFM/W)	360	337
ENERGY COSTS (YEARLY)	\$10.09	\$7.00
AMPS	0.47	0.27
RPMS	97	63

60" MARIN™

Modern meets maritime in the sleek Marin. Designed with a nautical flair in mind, Marin is available in Matte White, Metallic Matte Bronze or Matte Black finish and features composite blades. Marin is so versatile; it can be used for both indoor and outdoor spaces.



903160FMB-LDD
MATTE BLACK WITH
MATTE BLACK BLADES

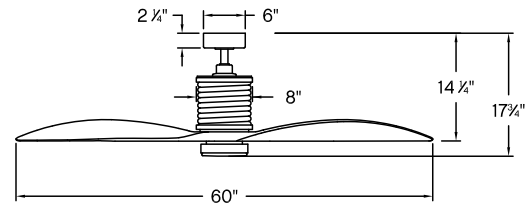

60" MARIN™

903160FMB-LDD - MATTE BLACK

903160FMM-NDD - METALLIC MATTE BRONZE

903160FMW-NDD - MATTE WHITE

BLADES:

- 3 Composite Blades Included
- 16° Blade Pitch
- 60" Blade Sweep

MOUNTING:

- 4.5" Downrod Included
- 76" Lead Wire
- 21 lbs. Hanging Weight
- Mounts to Sloped Ceilings
- Up to 20° Pitch

Slope ceiling kit required for ceiling pitch greater than 20°, 992001FXX, see page 146.

LAMPING / GLASS:

- 16w LED Included
- 1500 Lumens | 90 CRI | 3000K
- Dimmable
- Etched Opal Glass

INCLUDED CONTROLS:

980014FWH-R
6 Speed HIRO Reversing



 Includes WiFi Enabled Control



Light Kit Cover
Included with Fan



903160FMW-NDD
MATTE WHITE WITH
WEATHERED WOOD BLADES



903160FMM-NDD
METALLIC MATTE BRONZE
WITH WALNUT BLADES

PERFORMANCE SPECIFICATIONS	STANDARD	
	HIGH SPEED	AVG SPEED
AIRFLOW (CFM)	6339	4792
ENERGY USE (WATTS)	26.5	17
AIRFLOW EFFICIENCY (CFM/W)	239	273
ENERGY COSTS (YEARLY)	\$7.00	\$5.00
AMPS	0.36	0.21
RPMS	105	75

56" HAMPTON™

Hampton is a modern transitional design, offering the ultimate in urban sophistication. The minimal, rectangular frame, paired with a decorative acrylic etched bottom lens and sleek blades is softened by a contemporary off-white linen drum shade. Available in Metallic Matte Bronze with Walnut or Metallic Matte Bronze blades, Brushed Nickel with Walnut or Silver blades, Heritage Brass with Birch or Matte White blades, Hampton is perfect for any interior decor.



903056FBN-LID
BRUSHED NICKEL WITH REVERSIBLE
WALNUT / SILVER BLADES

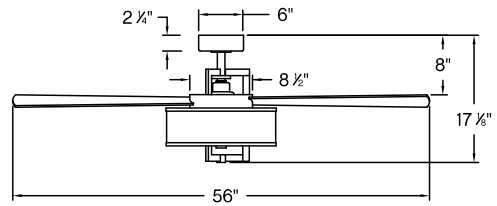

56" HAMPTON™

903056FBN-LID - BRUSHED NICKEL

903056FHB-LID - HERITAGE BRASS

903056FMM-LID - METALLIC MATTE BRONZE

BLADES:

- 5 Wood Blades Included
- 14° Blade Pitch
- 56" Blade Sweep

MOUNTING:

- 6" Downrod Included
- 76" Lead Wire
- 17.20 lbs. Hanging Weight
- Mounts to Sloped Ceilings
- Up to 20° Pitch

Slope ceiling kit required for ceiling pitch greater than 20°, 992001FXX, see page 146.

LAMPING / SHADE:

- 24w LED Included
- 2400 Lumens | 90 CRI | 3000K
- Dimmable
- White Linen Shade
- Etched Acrylic Lens

INCLUDED CONTROLS:

980014FWH-R
6 Speed HIRO Reversing



 Includes WiFi Enabled Control





903056FHB-LID
HERITAGE BRASS WITH REVERSIBLE
MATTE WHITE / BIRCH BLADES



903056FMM-LID
METALLIC MATTE BRONZE WITH REVERSIBLE
METALLIC MATTE BRONZE / WALNUT BLADES

REVERSIBLE BLADES:

- 
BRUSHED NICKEL
Walnut / Silver
- 
HERITAGE BRASS
Birch / Matte White
- 
METALLIC MATTE BRONZE
Walnut / Metallic Matte Bronze

PERFORMANCE SPECIFICATIONS	STANDARD	
	HIGH SPEED	AVG SPEED
AIRFLOW (CFM)	5233	3722
ENERGY USE (WATTS)	30.1	18
AIRFLOW EFFICIENCY (CFM/W)	174	202
ENERGY COSTS (YEARLY)	\$8.00	\$5.00
AMPS	0.41	0.23
RPMS	123	84

54" COLLIER™

Collier's mid-century silhouette incorporates the best in retro simplicity. Cast knobs, hinges and stems convey sleek elegance for a look that is at once modern and timeless. Available in Heritage Brass with Birch or Walnut blades, Matte Black with Walnut or Matte Black blades, Metallic Matte Bronze with Walnut or Metallic Matte Bronze blades, and Pewter with Matte Black or Birch blades, Collier features wood blades.



903254FHB-LID
HERITAGE BRASS WITH REVERSIBLE
BIRCH / WALNUT BLADES

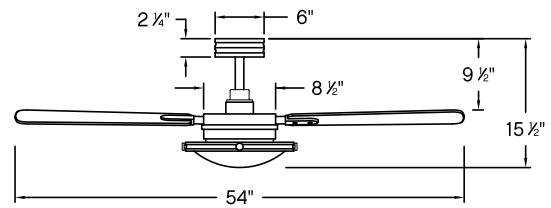

54" COLLIER™

903254FHB-LID - HERITAGE BRASS

903254FMB-LID - MATTE BLACK

903254FMM-LID - METALLIC MATTE BRONZE

903254FPW-LID - PEWTER

BLADES:

- 4 Wood Blades Included
- 13° Blade Pitch
- 54" Blade Sweep

MOUNTING:

- 6" Downrod Included
- 76" Lead Wire
- 18 lbs. Hanging Weight
- Mounts to Sloped Ceilings
- Up to 20° Pitch

Slope ceiling kit required for ceiling pitch greater than 20°, 992001FXX, see page 146.

LAMPING / GLASS:

- 24w LED Included
- 2400 Lumens | 90 CRI | 3000K
- Dimmable
- Etched Opal Glass

INCLUDED CONTROLS:

980014FWH-R
6 Speed HIRO Reversing



- Includes WiFi Enabled Control



903254FMB-LID
 MATTE BLACK WITH REVERSIBLE
 MATTE BLACK / WALNUT BLADES







903254FMM-LID
 METALLIC MATTE BRONZE WITH REVERSIBLE
 WALNUT / METALLIC MATTE BRONZE BLADES



903254FPW-LID
 PEWTER WITH REVERSIBLE
 MATTE BLACK / BIRCH BLADES

REVERSIBLE BLADES:

- 
HERITAGE BRASS
 Birch / Walnut
- 
MATTE BLACK
 Matte Black / Walnut
- 
METALLIC MATTE BRONZE
 Metallic Matte Bronze / Walnut
- 
PEWTER
 Birch / Matte Black

PERFORMANCE SPECIFICATIONS	STANDARD	
	HIGH SPEED	AVG SPEED
AIRFLOW (CFM)	5426	3617
ENERGY USE (WATTS)	34.1	20
AIRFLOW EFFICIENCY (CFM/W)	159	177
ENERGY COSTS (YEARLY)	\$10.00	\$6.00
AMPS	0.45	0.25
RPMS	148	97

56" INDY™

The raw, edgy style of Indy is the perfect complement for all modern industrial design-inspired rooms. Available in a Brushed Nickel, Matte Black, Matte White or Metallic Matte Bronze finish with complementing sleek aluminum blades. Indy is so versatile, it can be used for both indoor and outdoor spaces.



900956FMB-NWA
MATTE BLACK WITH
MATTE BLACK BLADES

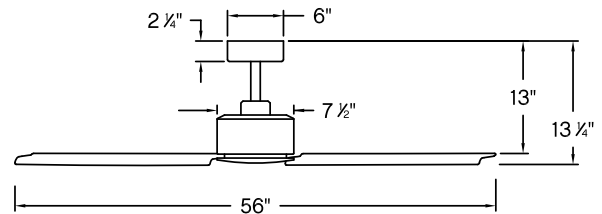

56" INDY™

900956FBN-NWA - BRUSHED NICKEL

900956FMB-NWA - MATTE BLACK

900956FMM-NWA - METALLIC MATTE BRONZE

900956FMW-NWA - MATTE WHITE

BLADES:

- 3 Aluminum Blades Included
- 35° Blade Pitch
- 56" Blade Sweep

MOUNTING:

- 6" Downrod Included
- 76" Lead Wire
- 17.77 lbs. Hanging Weight
- Mounts to Sloped Ceilings
 - Up to 20° Pitch

Slope ceiling kit required for ceiling pitch greater than 20°, 992001FXX, see page 146.

INCLUDED CONTROLS:

980011FWH

Wall Control 4 Speed Slide

- Manual Reverse





900956FBN-NWA
BRUSHED NICKEL WITH
BRUSHED NICKEL BLADES



900956FMW-NWA
MATTE WHITE WITH
MATTE WHITE BLADES



900956FMM-NWA
METALLIC MATTE BRONZE WITH
METALLIC MATTE BRONZE BLADES

OPTIONAL CONTROLS:



980018FWH-0095
WiFi HIRO Remote
Control Accessory



PERFORMANCE SPECIFICATIONS	STANDARD	
	HIGH SPEED	AVG SPEED
AIRFLOW (CFM)	5306	3785
ENERGY USE (WATTS)	57.6	36
AIRFLOW EFFICIENCY (CFM/W)	92	105
ENERGY COSTS (YEARLY)	\$16.00	\$10.00
AMPS	0.48	0.34
RPMS	159	112

72" INDY™

The raw, edgy style of Indy is the perfect complement for all modern industrial design-inspired rooms. Available in Brushed Nickel, Matte Black, Matte White or Metallic Matte Bronze finish, this UL wet location fan features three sleek composite blades. Indy is so versatile, it can be used for both indoor and outdoor spaces.



900972FMB-NWA
MATTE BLACK WITH
MATTE BLACK BLADES

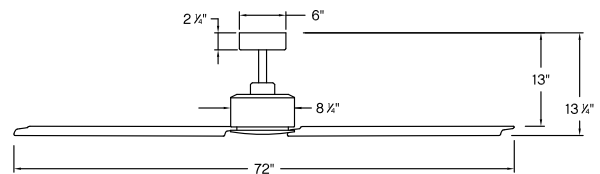

72" INDY™

900972FBN-NWA - BRUSHED NICKEL

900972FMB-NWA - MATTE BLACK

900972FMM-NWA - METALLIC MATTE BRONZE

900972FMW-NWA - MATTE WHITE

BLADES:

- 3 Composite Blades Included
- 55° Blade Pitch
- 72" Blade Sweep

MOUNTING:

- 6" Downrod Included
- 76" Lead Wire
- 22 lbs. Hanging Weight
- Mounts to Sloped Ceilings
 - Up to 20° Pitch

Slope ceiling kit required for ceiling pitch greater than 20°, 992001FXX, refer to XX.

INCLUDED CONTROLS:

- 980011FWH**
Wall Control 4 Speed Slide
- Manual Reverse





900972FBN-NWA
BRUSHED NICKEL WITH
BRUSHED NICKEL BLADES



900972FMW-NWA
MATTE WHITE WITH
MATTE WHITE BLADES



900972FMM-NWA
METALLIC MATTE BRONZE WITH
METALLIC MATTE BRONZE BLADES

OPTIONAL CONTROLS:



980018FWH-0097
WiFi HIRO Remote
Control Accessory



PERFORMANCE SPECIFICATIONS	STANDARD	
	HIGH SPEED	AVG SPEED
AIRFLOW (CFM)	6425	4465
ENERGY USE (WATTS)	62.6	39
AIRFLOW EFFICIENCY (CFM/W)	103	115
ENERGY COSTS (YEARLY)	\$18.00	\$11.00
AMPS	0.52	0.37
RPMS	83	72

58" INDY FLUSH™

The raw, edgy style of Indy Flush is the perfect complement for all modern industrial design-inspired rooms. Available in Brushed Nickel, Matte Black, Matte White or Metallic Matte Bronze finish options, Indy Flush features sleek aluminum blades. Indy Flush is so versatile; it can be used for both indoor and outdoor spaces.



901058FMW-NDD
MATTE WHITE WITH
MATTE WHITE BLADES

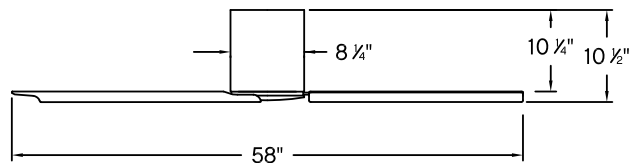

DESCRIPTION

901058FBN-NDD - BRUSHED NICKEL

901058FMB-NDD - MATTE BLACK

901058FMM-NDD - METALLIC MATTE BRONZE

901058FMW-NDD - MATTE WHITE

BLADES:

- 3 Aluminum Blades Included
- 55° Blade Pitch
- 58" Blade Sweep

MOUNTING:

- 12" Lead Wire
- 18 lbs. Hanging Weight

INCLUDED CONTROLS:

980014FWH-R
6 Speed HIRO Reversing



- Includes WiFi Enabled Control



901058FBN-NDD
BRUSHED NICKEL WITH
BRUSHED NICKEL BLADES



901058FMB-NDD
MATTE BLACK WITH
MATTE BLACK BLADES



901058FMM-NDD
METALLIC MATTE BRONZE WITH
METALLIC MATTE BRONZE BLADES

PERFORMANCE SPECIFICATIONS	STANDARD	
	HIGH SPEED	AVG SPEED
AIRFLOW (CFM)	6371	3781
ENERGY USE (WATTS)	28.5	19
AIRFLOW EFFICIENCY (CFM/W)	224	196
ENERGY COSTS (YEARLY)	\$7.99	\$5.00
AMPS	0.39	0.22
RPMS	157	92

72" INDY FLUSH™

The raw, edgy style of Indy Flush is the perfect complement for all modern industrial design-inspired rooms. Available in Brushed Nickel, Matte Black, Matte White or Metallic Matte Bronze finish options, Indy Flush features sleek composite blades. Indy Flush is so versatile; it can be used for both indoor and outdoor spaces.



901072FMM-NDD
METALLIC MATTE BRONZE WITH
METALLIC MATTE BRONZE BLADES

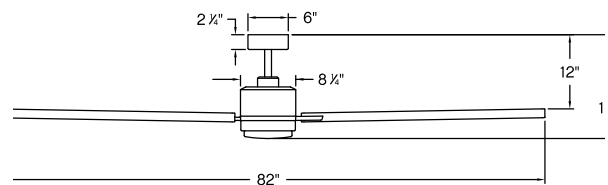

DESCRIPTION

901072FBN-NDD - BRUSHED NICKEL

901072FMB-NDD - MATTE BLACK

901072FMM-NDD - METALLIC MATTE BRONZE

901072FMW-NDD - MATTE WHITE

BLADES:

- 3 Composite Blades Included
- 55° Blade Pitch
- 72" Blade Sweep

MOUNTING:

- 12" Lead Wire
- 19 lbs. Hanging Weight

INCLUDED CONTROLS:

980014FWH-R
6 Speed HIRO Reversing



- Includes WiFi Enabled Control



901072FMB-NDD
 MATTE BLACK WITH
 MATTE BLACK BLADES



901072FBN-NDD
 BRUSHED NICKEL WITH
 BRUSHED NICKEL BLADES



901072FMW-NDD
 MATTE WHITE WITH
 MATTE WHITE BLADES

PERFORMANCE SPECIFICATIONS	STANDARD	
	HIGH SPEED	AVG SPEED
AIRFLOW (CFM)	6671	3951
ENERGY USE (WATTS)	31.8	21
AIRFLOW EFFICIENCY (CFM/W)	210	185
ENERGY COSTS (YEARLY)	\$8.91	\$6.00
AMPS	0.41	0.23
RPMS	105	67

82" INDY MAXX™

The raw, edgy style of Indy Maxx is the perfect complement for all modern industrial design-inspired rooms. Available in Brushed Nickel, Matte Black, Metallic Matte Bronze and Matte White, Indy Maxx features sleek aluminum blades. Indy Maxx is so versatile; it can be used for both indoor and outdoor spaces.



900982FBN-LDD
BRUSHED NICKEL WITH
BRUSHED NICKEL BLADES

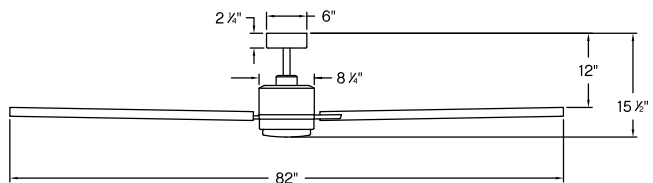

82" INDY MAXX™

900982FBN-LDD - BRUSHED NICKEL

900982FMB-LDD - MATTE BLACK

900982FMM-LDD - METALLIC MATTE BRONZE

900982FMW-LDD - MATTE WHITE

BLADES:

- 6 Aluminum Blades Included
- 20° Blade Pitch
- 82" Blade Sweep

MOUNTING:

- 6" Downrod Included
- 76" Lead Wire
- 33.29 lbs. Hanging Weight
- Mounts to Sloped Ceilings
- Up to 20° Pitch

Slope ceiling kit required for ceiling pitch greater than 20°, 992001FXX, see page 146.

LAMPING / GLASS:

- 16w LED Included
- 1500 Lumens | 90 CRI | 3000K
- Dimmable
- Etched Opal Glass

INCLUDED CONTROLS:

980014FWH-R
6 Speed HIRO Reversing



 Includes WiFi Enabled Control



900982FMB-LDD
 MATTE BLACK WITH
 MATTE BLACK BLADES

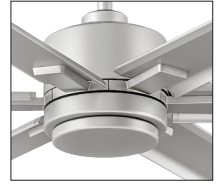

Light Kit Cover
 Included with Fan



900982FMW-LDD
 MATTE WHITE WITH
 MATTE WHITE BLADES



900982FMM-LDD
 METALLIC MATTE BRONZE WITH
 METALLIC MATTE BRONZE BLADES

PERFORMANCE SPECIFICATIONS	STANDARD	
	HIGH SPEED	AVG SPEED
AIRFLOW (CFM)	9867	6849
ENERGY USE (WATTS)	38.9	27
AIRFLOW EFFICIENCY (CFM/W)	253	254
ENERGY COSTS (YEARLY)	\$11.00	\$8.00
AMPS	0.51	0.29
RPMS	80	55

99" INDY MAXX™

The raw, edgy style of Indy Maxx is the perfect complement for all modern industrial design-inspired rooms. Available in Brushed Nickel, Matte Black, Metallic Matte Bronze and Matte White, Indy Maxx features sleek aluminum blades. Indy Maxx is so versatile; it can be used for both indoor and outdoor spaces.



900999FMM-LDD
METALLIC MATTE BRONZE WITH
METALLIC MATTE BRONZE BLADES

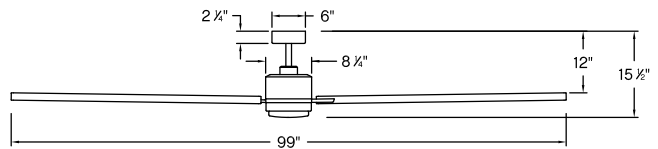

99" INDY MAXX™

900999FBN-LDD - BRUSHED NICKEL

900999FMB-LDD - MATTE BLACK

900999FMM-LDD - METALLIC MATTE BRONZE

900999FMW-LDD - MATTE WHITE

BLADES:

- 6 Aluminum Blades Included
- 20° Blade Pitch
- 99" Blade Sweep

MOUNTING:

- 6" Downrod Included
- 76" Lead Wire
- 37 lbs. Hanging Weight
- Mounts to Sloped Ceilings
 - Up to 20° Pitch

Slope ceiling kit required for ceiling pitch greater than 20°, 992001FXX, see page 146.

LAMPING / GLASS:

- 16w LED Included
- 1500 Lumens | 90 CRI | 3000K
- Dimmable
- Etched Opal Glass

INCLUDED CONTROLS:

980014FWH-R
6 Speed HIRO Reversing



 Includes WiFi Enabled Control



Light Kit Cover
Included with Fan



900999FBN-LDD
BRUSHED NICKEL WITH
BRUSHED NICKEL BLADES



900999FMB-LDD
MATTE BLACK WITH
MATTE BLACK BLADES



900999FMW-LDD
MATTE WHITE WITH
MATTE WHITE BLADES

PERFORMANCE SPECIFICATIONS	STANDARD	
	HIGH SPEED	AVG SPEED
AIRFLOW (CFM)	10775	7985
ENERGY USE (WATTS)	41.5	30
AIRFLOW EFFICIENCY (CFM/W)	260	266
ENERGY COSTS (YEARLY)	\$12.00	\$8.00
AMPS	0.54	0.32
RPMS	66	48

60" SCULPT™

Sculpt defines modern elegance. Its solid wood blades are complemented by a clean etched opal glass, seamlessly adding the adequate amount of contemporary character. Sculpt is available in Matte Black with Walnut blades or Graphite with Driftwood blades. Sculpt is DAMP rated, making it perfect for both interior and outdoor settings.



903660FGT-LDD
GRAPHITE WITH DRIFTWOOD BLADES

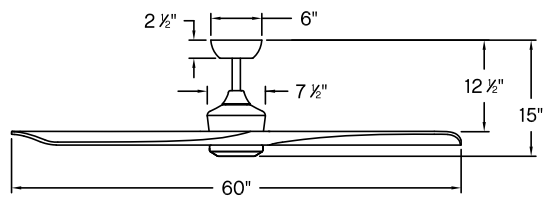

60" SCULPT™

903660FGT-LDD - GRAPHITE

903660FMB-LDD - MATTE BLACK

BLADES:

- 3 Wood Blades Included
- 14° Blade Pitch
- 60" Blade Sweep

MOUNTING:

- 6" Downrod Included
- 76" Lead Wire
- 17.2 lbs. Hanging Weight
- Mounts to Sloped Ceilings
- Up to 20° Pitch

Slope ceiling kit required for ceiling pitch greater than 20°, 992001FXX, see page 146.

LAMPING / GLASS:

- 16w LED Included
- 1500 Lumens | 90 CRI | 3000K
- Dimmable
- Etched Opal Glass

INCLUDED CONTROLS:

980014FWH-R

6 Speed HIRO Reversing



Includes WiFi Enabled Control



Light Kit Cover
Included with Fan



903660FMB-LDD
MATTE BLACK WITH WALNUT BLADES

PERFORMANCE SPECIFICATIONS	STANDARD	
	HIGH SPEED	AVG SPEED
AIRFLOW (CFM)	8752	6079
ENERGY USE (WATTS)	32.4	20.0
AIRFLOW EFFICIENCY (CFM/W)	270	298
ENERGY COSTS (YEARLY)	\$9.00	\$6.00
AMPS	0.50	0.29
RPMS	185	119

80" SCULPT™

Sculpt defines modern elegance. Its solid wood blades are complemented by a clean etched opal glass, seamlessly adding the adequate amount of contemporary character. Sculpt is available in Matte Black with Walnut blades or Graphite with Driftwood blades. Sculpt is DAMP rated, making it perfect for both interior and outdoor settings.



903680FMB-LDD
MATTE BLACK WITH WALNUT BLADES

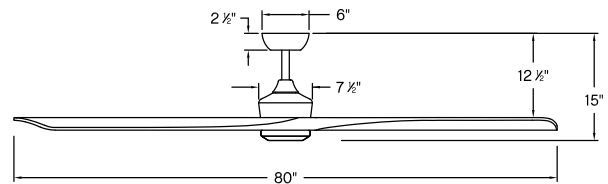

80" SCULPT™

903680FGT-LDD - GRAPHITE

903680FMB-LDD - MATTE BLACK

BLADES:

- 3 Wood Blades Included
- 14° Blade Pitch
- 80" Blade Sweep

MOUNTING:

- 6" Downrod Included
- 76" Lead Wire
- 19.18 lbs. Hanging Weight
- Mounts to Sloped Ceilings
- Up to 20° Pitch

Slope ceiling kit required for ceiling pitch greater than 20°, 992001FXX, see page 146.

LAMPING / GLASS:

- 16w LED Included
- 1500 Lumens | 90 CRI | 3000K
- Dimmable
- Etched Opal Glass

INCLUDED CONTROLS:

980014FWH-R
6 Speed HIRO Reversing



- Includes WiFi Enabled Control



Light Kit Cover
Included with Fan



903680FGT-LDD
GRAPHITE WITH DRIFTWOOD BLADES

PERFORMANCE SPECIFICATIONS	STANDARD	
	HIGH SPEED	AVG SPEED
AIRFLOW (CFM)	11023	8548
ENERGY USE (WATTS)	33.1	19.0
AIRFLOW EFFICIENCY (CFM/W)	333	439
ENERGY COSTS (YEARLY)	\$9.00	\$5.00
AMPS	0.47	0.28
RPMS	115	83

44" CHISEL™

Built with a sleek, carefully crafted design, Chisel redefines dramatic style. Made of sturdy solid wood blades, Chisel is available in Matte Black with Walnut blades, Matte White with Weathered Wood blades, and Graphite with Driftwood blades. Chisel is DAMP rated, making it perfect for both interior and outdoor settings.



903744FGT-NDD
GRAPHITE WITH DRIFTWOOD BLADES

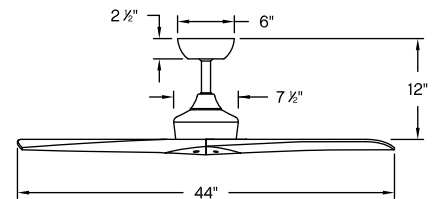

44" CHISEL™

903744FGT-NDD - GRAPHITE

903744FMB-NDD - MATTE BLACK

903744FMW-NDD - MATTE WHITE

BLADES:

- 3 Wood Blades Included
- 14° Blade Pitch
- 44" Blade Sweep

MOUNTING:

- 6" Downrod Included
- 76" Lead Wire
- 13.45 lbs. Hanging Weight
- Mounts to Sloped Ceilings
 - Up to 20° Pitch

Slope ceiling kit required for ceiling pitch greater than 20°, 992001FXX, see page 146.

INCLUDED CONTROLS:

980014FWH-R
6 Speed HIRO Reversing



Includes WiFi Enabled Control



903744FMB-NDD
 MATTE BLACK WITH WALNUT BLADES



903744FMW-NDD
 MATTE WHITE WITH WEATHERED WOOD BLADES

PERFORMANCE SPECIFICATIONS	STANDARD	
	HIGH SPEED	AVG SPEED
AIRFLOW (CFM)	5032	3193
ENERGY USE (WATTS)	33.3	16.0
AIRFLOW EFFICIENCY (CFM/W)	151	200
ENERGY COSTS (YEARLY)	\$9.00	\$4.00
AMPS	0.36	0.21
RPMS	289	170

52" CHISEL™

Built with a sleek, carefully crafted design, Chisel redefines dramatic style. Made of sturdy solid wood blades, Chisel is available in Matte Black with Walnut blades, Matte White with Weathered Wood blades, and Graphite with Driftwood blades. Chisel is DAMP rated, making it perfect for both interior and outdoor settings.



903752FMW-NDD
MATTE WHITE WITH WEATHERED WOOD BLADES

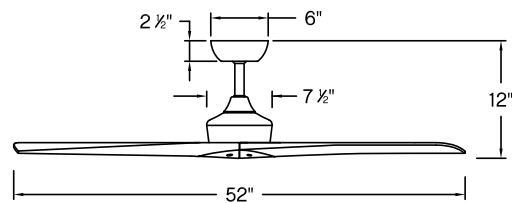

52" CHISEL™

903752FGT-NDD - GRAPHITE

903752FMB-NDD - MATTE BLACK

903752FMW-NDD - MATTE WHITE

BLADES:

- 3 Wood Blades Included
- 14° Blade Pitch
- 52" Blade Sweep

MOUNTING:

- 6" Downrod Included
- 76" Lead Wire
- 14.55 lbs. Hanging Weight
- Mounts to Sloped Ceilings
 - Up to 20° Pitch

Slope ceiling kit required for ceiling pitch greater than 20°, 992001FXX, see page 146.

INCLUDED CONTROLS:

980014FWH-R
6 Speed HIRO Reversing



Includes WiFi Enabled Control



903752FMB-NDD
 MATTE BLACK WITH WALNUT BLADES



903752FGT-NDD
 GRAPHITE WITH DRIFTWOOD BLADES

PERFORMANCE SPECIFICATIONS	STANDARD	
	HIGH SPEED	AVG SPEED
AIRFLOW (CFM)	6564	4404
ENERGY USE (WATTS)	30.0	19.0
AIRFLOW EFFICIENCY (CFM/W)	219	233
ENERGY COSTS (YEARLY)	\$8.00	\$5.00
AMPS	0.46	0.27
RPMS	222	138

60" CHISEL™

Built with a sleek, carefully crafted design, Chisel redefines dramatic style. Made of sturdy solid wood blades, Chisel is available in Matte Black with Walnut blades, Matte White with Weathered Wood blades, and Graphite with Driftwood blades. Chisel is DAMP rated, making it perfect for both interior and outdoor settings.



903760FGT-NDD
GRAPHITE WITH DRIFTWOOD BLADES

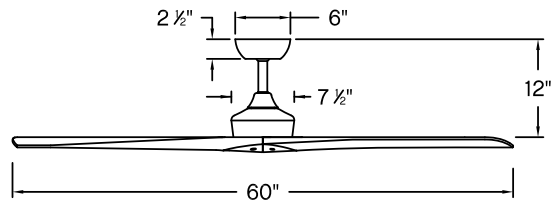

60" CHISEL™

903760FGT-NDD - GRAPHITE

903760FMB-NDD - MATTE BLACK

903760FMW-NDD - MATTE WHITE

BLADES:

- 3 Wood Blades Included
- 14° Blade Pitch
- 60" Blade Sweep

MOUNTING:

- 6" Downrod Included
- 76" Lead Wire
- 16.1 lbs. Hanging Weight
- Mounts to Sloped Ceilings
 - Up to 20° Pitch

Slope ceiling kit required for ceiling pitch greater than 20°, 992001FXX, see page 146.

INCLUDED CONTROLS:

980014FWH-R
6 Speed HIRO Reversing



 Includes WiFi Enabled Control



903760FGT-NDD
 GRAPHITE WITH DRIFTWOOD BLADES



903760FMW-NDD
 MATTE WHITE WITH WEATHERED WOOD BLADES

PERFORMANCE SPECIFICATIONS	STANDARD	
	HIGH SPEED	AVG SPEED
AIRFLOW (CFM)	8035	5564
ENERGY USE (WATTS)	33.6	20.0
AIRFLOW EFFICIENCY (CFM/W)	239	282
ENERGY COSTS (YEARLY)	\$9.00	\$6.00
AMPS	0.48	0.28
RPMS	177	114

60" SWELL™

Swell is sophisticated and distinct in design without sacrificing on its purpose. Available in Matte Black with Walnut blades or Graphite with Driftwood blades, Swell sets the tone for all contemporary spaces. Swell is DAMP rated, making it perfect for both interior and outdoor settings.



903860FGT-NDD
GRAPHITE WITH DRIFTWOOD BLADES

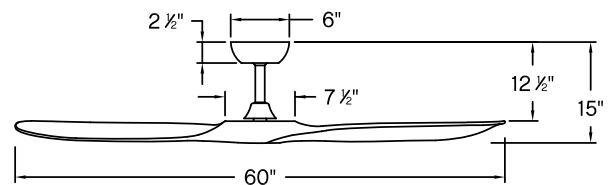

60" SWELL™

903860FGT-NDD - GRAPHITE

903860FMB-NDD - MATTE BLACK

BLADES:

- 3 Wood Blades Included
- 14° Blade Pitch
- 60" Blade Sweep

MOUNTING:

- 6" Downrod Included
- 76" Lead Wire
- 16.1 lbs. Hanging Weight
- Mounts to Sloped Ceilings
 - Up to 20° Pitch

Slope ceiling kit required for ceiling pitch greater than 20°, 992001FXX, see page 146.

INCLUDED CONTROLS:

980014FWH-R
6 Speed HIRO Reversing



- Includes WiFi Enabled Control



903860FMB-NDD
MATTE BLACK WITH WALNUT BLADES

PERFORMANCE SPECIFICATIONS	STANDARD	
	HIGH SPEED	AVG SPEED
AIRFLOW (CFM)	8521	6059
ENERGY USE (WATTS)	30.5	19
AIRFLOW EFFICIENCY (CFM/W)	279	325
ENERGY COSTS (YEARLY)	\$9.00	\$5.00
AMPS	0.47	0.28
RPMS	155	106

80" SWELL™

Swell is sophisticated and distinct in design without sacrificing on its purpose. Available in Matte Black with Walnut blades or Graphite with Driftwood blades, Swell sets the tone for all contemporary spaces. Swell is DAMP rated, making it perfect for both interior and outdoor settings.



903880FMB-NDD
MATTE BLACK WITH WALNUT BLADES

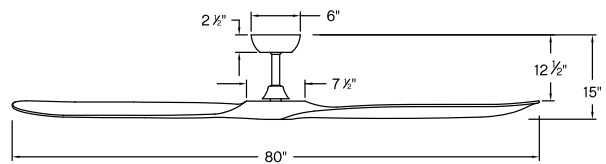

80" SWELL™

903880FGT-NDD - GRAPHITE

903880FMB-NDD - MATTE BLACK

BLADES:

- 3 Wood Blades Included
- 14° Blade Pitch
- 80" Blade Sweep

MOUNTING:

- 6" Downrod Included
- 76" Lead Wire
- 17.42 lbs. Hanging Weight
- Mounts to Sloped Ceilings
 - Up to 20° Pitch

Slope ceiling kit required for ceiling pitch greater than 20°, 992001FXX, see page 146.

INCLUDED CONTROLS:

980014FWH-R
6 Speed HIRO Reversing



 Includes WiFi Enabled Control



903880FGT-NDD
 GRAPHITE WITH DRIFTWOOD BLADES

PERFORMANCE SPECIFICATIONS	STANDARD	
	HIGH SPEED	AVG SPEED
AIRFLOW (CFM)	10955	8554
ENERGY USE (WATTS)	39.7	20
AIRFLOW EFFICIENCY (CFM/W)	276	433
ENERGY COSTS (YEARLY)	\$11.00	\$6.00
AMPS	0.50	0.30
RPMS	102	74

60" SWELL FLUSH™

Swell Flush is sophisticated and distinct in design without sacrificing on its purpose. Available in Matte Black, Metallic Matte Bronze, or Matte White finish options, Swell Flush sets the tone for all contemporary spaces. Swell Flush is DAMP rated, making it perfect for both interior and outdoor settings.

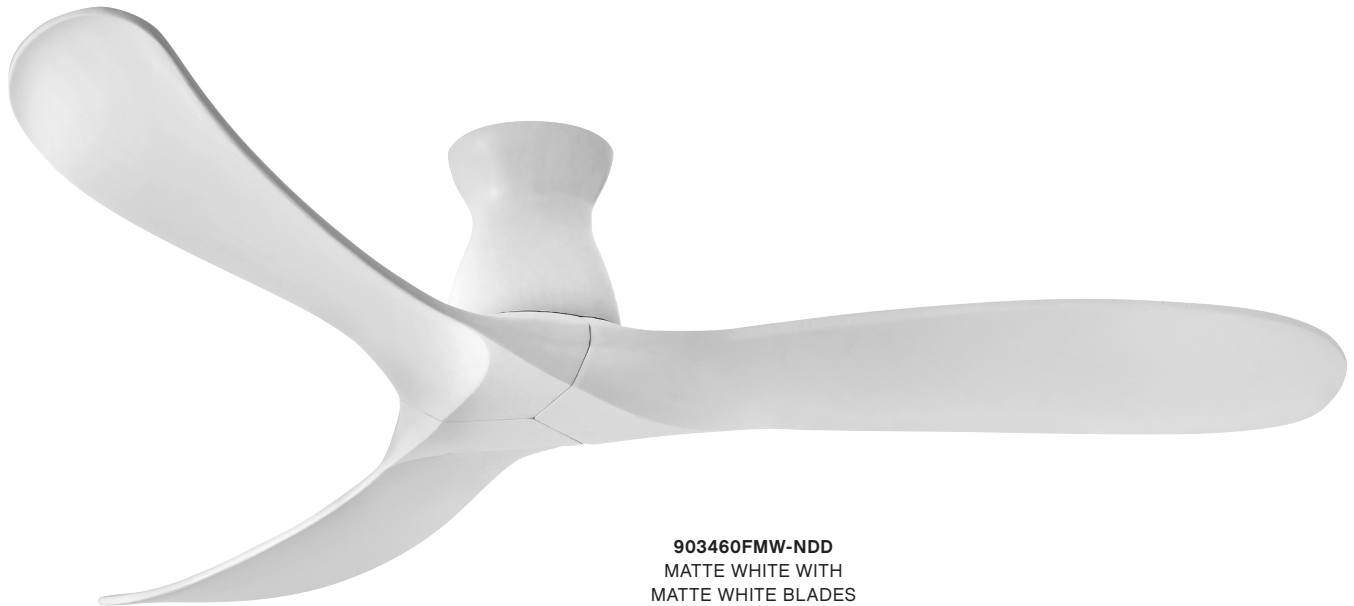

903460FMW-NDD
MATTE WHITE WITH
MATTE WHITE BLADES

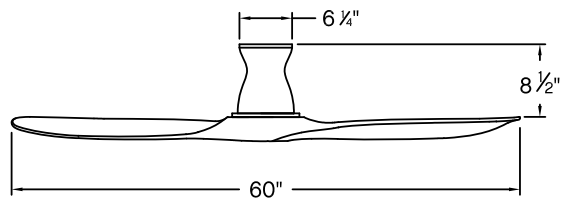

60" SWELL FLUSH™

903460FMB-NDD - MATTE BLACK

903460FMM-NDD - METALLIC MATTE BRONZE

903460FMW-NDD - MATTE WHITE

BLADES:

- 3 Wood Blades Included
- 14° Blade Pitch
- 60" Blade Sweep

MOUNTING:

- 12" Lead Wire
- 16.1 lbs. Hanging Weight

INCLUDED CONTROLS:

980014FWH-R
6 Speed HIRO Reversing



Includes WiFi Enabled Control



903460FMM-NDD
 METALLIC MATTE BRONZE WITH
 WALNUT BLADES



903460FMB-NDD
 MATTE BLACK WITH
 DRIFTWOOD BLADES

PERFORMANCE SPECIFICATIONS	STANDARD	
	HIGH SPEED	AVG SPEED
AIRFLOW (CFM)	7900	5452
ENERGY USE (WATTS)	34	24
AIRFLOW EFFICIENCY (CFM/W)	232	225
ENERGY COSTS (YEARLY)	\$9.00	\$7.00
AMPS	0.52	0.23
RPMS	157	116

52" HOVER™

Clean and chic, Hover is a stunning modern upgrade for any project. Available in Brushed Nickel, Graphite, Matte White or Matte Black, Hover comes equipped with integrated warm-dim LED and DC motor technology to deliver excellent energy efficiency. Hover is impressively designed to be used for both indoor and outdoor spaces.



900752FWK-LWD
MATTE WHITE WITH
KOA BLADES

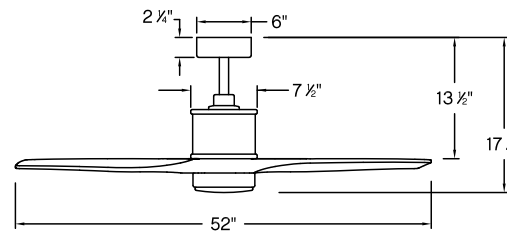

52" HOVER™

- 900752FBN-LWD - BRUSHED NICKEL
- 900752FGT-LWD - GRAPHITE
- 900752FMB-LWD - MATTE BLACK
- 900752FMW-LWD - MATTE WHITE
- 900752FWK-LWD - MATTE WHITE (KOA)

BLADES:

- 3 Composite Blades Included
- 14° Blade Pitch
- 52" Blade Sweep

MOUNTING:

- 6" Downrod Included
- 76" Lead Wire
- 16 lbs. Hanging Weight
- Mounts to Sloped Ceilings
- Up to 23° Pitch

Slope ceiling kit required for ceiling pitch greater than 23°, 992001FXX, see page 146.

LAMPING / GLASS:

- 16w LED Included
- 1320 Lumens | 90 CRI | 3000K
- Dimmable - Warm Dim
- Etched Opal Glass

INCLUDED CONTROLS:

- 980014FWH-R**
- 6 Speed HIRO Reversing



-  Includes WiFi Enabled Control



900752FBN-LWD
BRUSHED NICKEL WITH
WEATHERED WOOD BLADES



932007FXX
Light Kit Cover
Accessory



900752FGT-LWD
GRAPHITE WITH
DRIFTWOOD BLADES



900752FMB-LWD
MATTE BLACK WITH
KOA BLADES



900752FMW-LWD
MATTE WHITE
WITH MATTE WHITE BLADES

PERFORMANCE SPECIFICATIONS	STANDARD	
	HIGH SPEED	AVG SPEED
AIRFLOW (CFM)	5753	3713
ENERGY USE (WATTS)	18.3	12
AIRFLOW EFFICIENCY (CFM/W)	314	311
ENERGY COSTS (YEARLY)	\$5.00	\$3.00
AMPS	0.28	0.17
RPMS	169	108

60" HOVER™

Clean and chic, Hover is a stunning modern upgrade for any project. Available in Brushed Nickel, Graphite, Matte White or Matte Black, Hover comes equipped with integrated warm-dim LED and DC motor technology to deliver excellent energy efficiency. Hover is impressively designed to be used for both indoor and outdoor spaces.



900760FMB-LWD
MATTE BLACK WITH
KOA BLADES

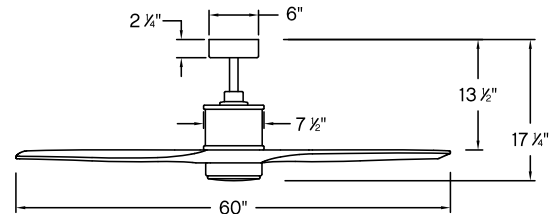

60" HOVER™

900760FBN-LWD - BRUSHED NICKEL

900760FGT-LWD - GRAPHITE

900760FMB-LWD - MATTE BLACK

900760FMW-LWD - MATTE WHITE

900760FWK-LWD - MATTE WHITE (KOA)

BLADES:

- 3 Composite Blades Included
- 14° Blade Pitch
- 60" Blade Sweep

MOUNTING:

- 6" Downrod Included
- 76" Lead Wire
- 22 lbs. Hanging Weight
- Mounts to Sloped Ceilings
- Up to 23° Pitch

Slope ceiling kit required for ceiling pitch greater than 23°, 992001FXX, see page 146.

LAMPING / GLASS:

- 16w LED Included
- 1320 Lumens | 90 CRI | 3000K
- Dimmable - Warm Dim
- Etched Opal Glass

INCLUDED CONTROLS:

980014FWH-R
6 Speed HIRO Reversing



 Includes WiFi Enabled Control



900760FWK-LWD
MATTE WHITE WITH
KOA BLADES



932007FXX
Light Kit Cover
Accessory



900760FGT-LWD
GRAPHITE WITH
DRIFTWOOD BLADES



900760FBN-LWD
BRUSHED NICKEL WITH
WEATHERED WOOD BLADES



900760FMW-LWD
MATTE WHITE
WITH MATTE WHITE BLADES

PERFORMANCE SPECIFICATIONS	STANDARD	
	HIGH SPEED	AVG SPEED
AIRFLOW (CFM)	7118	4714
ENERGY USE (WATTS)	28.5	18
AIRFLOW EFFICIENCY (CFM/W)	249	267
ENERGY COSTS (YEARLY)	\$8.00	\$5.00
AMPS	0.37	0.21
RPMS	150	98

52" HOVER FLUSH™

Clean and sleek, Hover Flush is a stunning modern upgrade for any project. Available in Matte Black, Brushed Nickel, Graphite, or Matte White, Hover Flush comes equipped with integrated warm-dim LED lighting and DC motor technology to deliver excellent energy efficiency. Hover Flush is so versatile, it can be used for both indoor and outdoor spaces.



900852FMW-LWD
MATTE WHITE
WITH MATTE WHITE BLADES

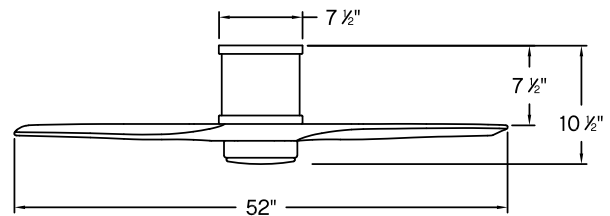

52" HOVER FLUSH™

900852FBN-LWD - BRUSHED NICKEL

900852FGT-LWD - GRAPHITE

900852FMB-LWD - MATTE BLACK

900852FMW-LWD - MATTE WHITE

BLADES:

- 3 Composite Blades Included
- 14° Blade Pitch
- 52" Blade Sweep

MOUNTING:

- 8" Lead Wire
- 14.07 lbs. Hanging Weight

LAMPING / GLASS:

- 16w LED Included
- 1320 Lumens | 90 CRI | 3000K
- Dimmable - Warm Dim
- Etched Opal Glass

INCLUDED CONTROLS:

980014FWH-R
6 Speed HIRO Reversing



 Includes WiFi Enabled Control



900852FGT-LWD
 GRAPHITE WITH
 DRIFTWOOD BLADES



932007FXX
 Light Kit Cover
 Accessory



900852FMB-LWD
 MATTE BLACK WITH
 KOA BLADES



900852FBN-LWD
 BRUSHED NICKEL WITH
 WEATHERED WOOD BLADES

PERFORMANCE SPECIFICATIONS	STANDARD	
	HIGH SPEED	AVG SPEED
AIRFLOW (CFM)	4957	3174
ENERGY USE (WATTS)	20.5	13.1
AIRFLOW EFFICIENCY (CFM/W)	242	243
ENERGY COSTS (YEARLY)	\$6.00	\$4.00
AMPS	0.31	0.18
RPMS	170	108

60" HOVER FLUSH™

Clean and sleek, Hover Flush is a stunning modern upgrade for any project. Available in Matte Black, Brushed Nickel, Graphite, or Matte White, Hover Flush comes equipped with integrated warm-dim LED lighting and DC motor technology to deliver excellent energy efficiency. Hover Flush is so versatile, it can be used for both indoor and outdoor spaces.



900860FBN-LWD
BRUSHED NICKEL WITH
WEATHERED WOOD BLADES

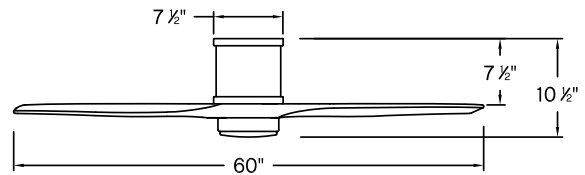

60" HOVER FLUSH™

900860FBN-LWD - BRUSHED NICKEL

900860FGT-LWD - GRAPHITE

900860FMB-LWD - MATTE BLACK

900860FMW-LWD - MATTE WHITE

BLADES:

- 3 Composite Blades Included
- 14° Blade Pitch
- 60" Blade Sweep

MOUNTING:

- 8" Lead Wire
- 14.28 lbs. Hanging Weight

LAMPING / GLASS:

- 16w LED Included
- 1320 Lumens | 90 CRI | 3000K
- Dimmable - Warm Dim
- Etched Opal Glass

INCLUDED CONTROLS:

980014FWH-R
6 Speed HIRO Reversing



 Includes WiFi Enabled Control



900860FMB-LWD
 MATTE BLACK WITH
 KOA BLADES



932007FXX
 Light Kit Cover
 Accessory



900860FGT-LWD
 GRAPHITE WITH
 DRIFTWOOD BLADES



900860FMW-LWD
 MATTE WHITE WITH
 MATTE WHITE BLADES

PERFORMANCE SPECIFICATIONS	STANDARD	
	HIGH SPEED	AVG SPEED
AIRFLOW (CFM)	6025	4027
ENERGY USE (WATTS)	31.8	19
AIRFLOW EFFICIENCY (CFM/W)	190	207
ENERGY COSTS (YEARLY)	\$9.00	\$5.00
AMPS	0.43	0.24
RPMS	150	98

72" HOVER FLUSH™

Clean and sleek, Hover Flush is a stunning modern upgrade for any project. Available in Matte Black, Brushed Nickel, Graphite, Matte White or Metallic Matte Bronze, Hover Flush comes equipped with integrated warm-dim LED and DC motor technology to deliver excellent energy efficiency. Hover Flush is so versatile, it can be used for both indoor and outdoor spaces.



900872FMM-LWD
METALLIC MATTE BRONZE WITH
WALNUT BLADES

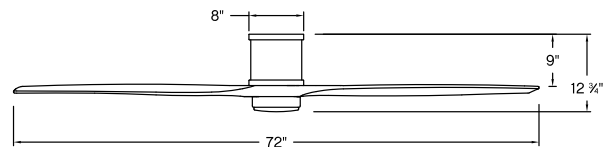

72" HOVER FLUSH™

900872FBN-LWD - BRUSHED NICKEL

900872FGT-LWD - GRAPHITE

900872FMB-LWD - MATTE BLACK

900872FMM-LWD - METALLIC MATTE BRONZE

900872FMW-LWD - MATTE WHITE

BLADES:

- 3 Composite Blades Included
- 14° Blade Pitch
- 72" Blade Sweep

MOUNTING:

- 12" Lead Wire
- 19 lbs. Hanging Weight

LAMPING / GLASS:

- 16w LED Included
- 1320 Lumens | 90 CRI | 3000K
- Dimmable - Warm Dim
- Etched Opal Glass

INCLUDED CONTROLS:

980014FWH-R
6 Speed HIRO Reversing



Includes WiFi Enabled Control



900872FBN-LWD
BRUSHED NICKEL WITH
WEATHERED WOOD BLADES



932007FXX
Light Kit Cover
Accessory



900872FGT-LWD
GRAPHITE WITH
DRIFTWOOD BLADES



900872FMW-LWD
MATTE WHITE WITH
MATTE WHITE BLADES



900872FMB-LWD
MATTE BLACK WITH
MATTE BLACK BLADES

PERFORMANCE SPECIFICATIONS	STANDARD	
	HIGH SPEED	AVG SPEED
AIRFLOW (CFM)	7527	4678
ENERGY USE (WATTS)	27.3	19
AIRFLOW EFFICIENCY (CFM/W)	276	246
ENERGY COSTS (YEARLY)	\$7.65	\$5.00
AMPS	0.38	0.21
RPMS	120	75

66" VANTAGE™

Create a major aesthetic statement with Vantage's modern industrial design featuring gently curved blades. Available in a variety of finish options, it can be applied to a range of spaces. Vantage is equipped with integrated LED and DC motor technology to deliver excellent energy efficiency. Vantage is so versatile, it can be used for both indoor and outdoor spaces.



902466FMB-LWD
MATTE BLACK WITH
MATTE BLACK BLADES

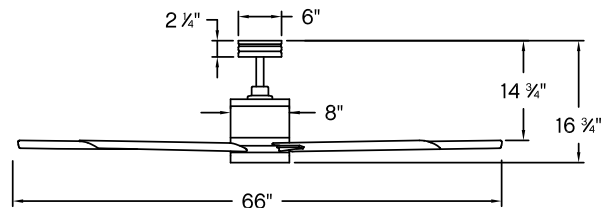

66" VANTAGE™

902466FBN-LWD - BRUSHED NICKEL

902466FGT-LWD - GRAPHITE

902466FMB-LWD - MATTE BLACK

902466FMM-LWD - METALLIC MATTE BRONZE

902466FMW-LWD - MATTE WHITE

BLADES:

- 8 Composite Blades Included
- 12.5° Blade Pitch
- 66" Blade Sweep

MOUNTING:

- 6" Downrod Included
- 76" Lead Wire
- 24.5 lbs. Hanging Weight
- Mounts to Sloped Ceilings
- Up to 20° Pitch

Slope ceiling kit required for ceiling pitch greater than 20°, 992001FXX, see page 146.

LAMPING / GLASS:

- 16w LED Included
- 1500 Lumens | 90 CRI | 3000K
- Dimmable
- Etched Opal Glass

INCLUDED CONTROLS:

980014FWH-R
6 Speed HIRO Reversing



 Includes WiFi Enabled Control



Light Kit Cover
Included with Fan



902466FBN-LWD
BRUSHED NICKEL WITH
SILVER BLADES



902466FGT-LWD
GRAPHITE WITH
DRIFTWOOD BLADES



902466FMW-LWD
MATTE WHITE WITH
MATTE WHITE BLADES



902466FMM-LWD
METALLIC MATTE BRONZE WITH
METALLIC MATTE BRONZE BLADES

PERFORMANCE SPECIFICATIONS	STANDARD	
	HIGH SPEED	AVG SPEED
AIRFLOW (CFM)	9087	6575
ENERGY USE (WATTS)	29.2	18
AIRFLOW EFFICIENCY (CFM/W)	312	356
ENERGY COSTS (YEARLY)	\$8.00	\$5.00
AMPS	0.41	0.24
RPMS	108	77

52" VAIL™

Vail offers a transitional design with gently curved blades and an array of finish options, while its integrated LED and DC motor technology deliver excellent energy efficiency. Vail is so versatile, it can be used for both indoor and outdoor spaces.



902152FBN-LWD
BRUSHED NICKEL WITH
SILVER BLADES

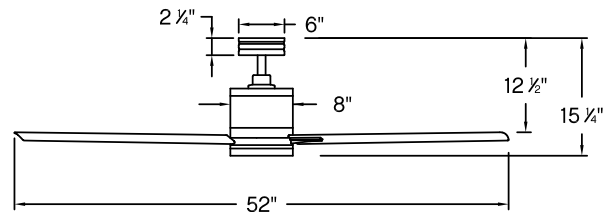

52" VAIL™

902152FBN-LWD - BRUSHED NICKEL

902152FGT-LWD - GRAPHITE

902152FMB-LWD - MATTE BLACK

902152FMM-LWD - METALLIC MATTE BRONZE

902152FMW-LWD - MATTE WHITE

BLADES:

- 5 Composite Blades Included
- 14° Blade Pitch
- 52" Blade Sweep

MOUNTING:

- 4.5" Downrod Included
- 76" Lead Wire
- 17.59 lbs. Hanging Weight
- Mounts to Sloped Ceilings
- Up to 20° Pitch

Slope ceiling kit required for ceiling pitch greater than 20°, 992001FXX, see page 146.

LAMPING / GLASS:

- 16w LED Included
- 1500 Lumens | 90 CRI | 3000K
- Dimmable
- Etched Opal Glass

INCLUDED CONTROLS:

980014FWH-R
6 Speed HIRO Reversing



 Includes WiFi Enabled Control



902152FMB-LWD
 MATTE BLACK WITH
 MATTE BLACK BLADES

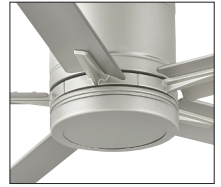

Light Kit Cover
 Included with Fan



902152FGT-LWD
 GRAPHITE WITH
 DRIFTWOOD BLADES



902152FMW-LWD
 MATTE WHITE WITH
 MATTE WHITE BLADES



902152FMM-LWD
 METALLIC MATTE BRONZE WITH
 METALLIC MATTE BRONZE BLADES

PERFORMANCE SPECIFICATIONS	STANDARD	
	HIGH SPEED	AVG SPEED
AIRFLOW (CFM)	6973	4582
ENERGY USE (WATTS)	28.3	17
AIRFLOW EFFICIENCY (CFM/W)	247	263
ENERGY COSTS (YEARLY)	\$8.00	\$5.00
AMPS	0.4	0.23
RPMS	160	103

52" VAIL FLUSH™

Vail Flush offers a transitional design with gently curved blades and an array of finish options, while its integrated LED and DC motor technology deliver excellent energy efficiency. Vail Flush is so versatile, it can be used for both indoor and outdoor spaces.



902552FMB-LWD
MATTE BLACK WITH
MATTE BLACK BLADES

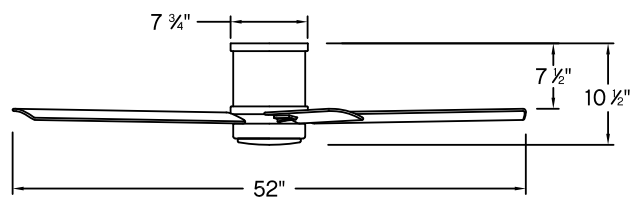

52" VAIL FLUSH™

902552FBN-LWD - BRUSHED NICKEL

902552FGT-LWD - GRAPHITE

902552FMB-LWD - MATTE BLACK

902552FMM-LWD - METALLIC MATTE BRONZE

902552FMW-LWD - MATTE WHITE

BLADES:

- 5 Composite Blades Included
- 14° Blade Pitch
- 52" Blade Sweep

MOUNTING:

- 12" Lead Wire
- 14.25 lbs. Hanging Weight

LAMPING / GLASS:

- 16w LED Included
- 1500 Lumens | 90 CRI | 3000K
- Dimmable
- Etched Opal Glass

INCLUDED CONTROLS:

980014FWH-R
6 Speed HIRO Reversing



 Includes WiFi Enabled Control



932007FXX
Light Kit Cover
Accessory



902552FBN-LWD
BRUSHED NICKEL WITH
SILVER BLADES



902552FGT-LWD
GRAPHITE WITH
DRIFTWOOD BLADES



902552FMW-LWD
MATTE WHITE WITH
MATTE WHITE BLADES



902552FMM-LWD
METALLIC MATTE BRONZE WITH
METALLIC MATTE BRONZE BLADES

PERFORMANCE SPECIFICATIONS	STANDARD	
	HIGH SPEED	AVG SPEED
AIRFLOW (CFM)	6280	4044
ENERGY USE (WATTS)	36.5	26
AIRFLOW EFFICIENCY (CFM/W)	172	156
ENERGY COSTS (YEARLY)	\$10.23	\$7.00
AMPS	0.48	0.27
RPMS	162	103

60" ARTISTE™

Artiste offers a transitional silhouette to enhance any and all spaces. Elegantly tapered blades are available in a wide array of fashionable finishes to cool and accentuate a space in style. Its integrated warm-dim LED and DC motor technology deliver excellent energy efficiency. Artiste is so versatile; it can be used for both indoor and outdoor spaces.



900160FMM-LWD
METALLIC MATTE BRONZE
WITH WALNUT BLADES

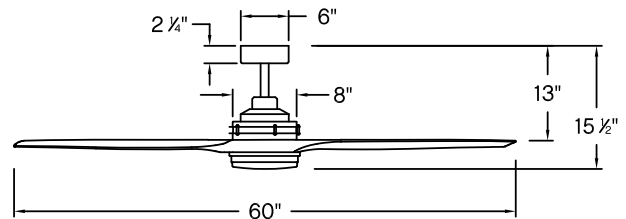

60" ARTISTE™

900160FBN-LWD - BRUSHED NICKEL

900160FGT-LWD - GRAPHITE

900160FMM-LWD - METALLIC MATTE BRONZE

900160FMW-LWD - MATTE WHITE

BLADES:

- 3 Composite Blades Included
- 14° Blade Pitch
- 60" Blade Sweep

MOUNTING:

- 6" Downrod Included
- 76" Lead Wire
- 17.02 lbs. Hanging Weight
- Mounts to Sloped Ceilings
- Up to 20° Pitch

Slope ceiling kit required for ceiling pitch greater than 20°, 992001FXX, see page 146.

LAMPING / GLASS:

- 16w LED Included
- 1320 Lumens | 90 CRI | 3000K
- Dimmable - Warm Dim
- Etched Opal Glass

INCLUDED CONTROLS:

980014FWH-R
6 Speed HIRO Reversing



 Includes WiFi Enabled Control



900160FBN-LWD
BRUSHED NICKEL
WITH SILVER BLADES



932001FXX
Light Kit Cover
Accessory



900160FGT-LWD
GRAPHITE WITH
DRIFTWOOD BLADES



900160FMW-LWD
MATTE WHITE WITH
MATTE WHITE BLADES

PERFORMANCE SPECIFICATIONS	STANDARD	
	HIGH SPEED	AVG SPEED
AIRFLOW (CFM)	7009	4639
ENERGY USE (WATTS)	20.5	13.3
AIRFLOW EFFICIENCY (CFM/W)	341	350
ENERGY COSTS (YEARLY)	\$6.00	\$4.00
AMPS	0.3	0.17
RPMS	150	98

72" ARTISTE™

Artiste offers a transitional silhouette to enhance any and all spaces. Elegantly tapered blades are available in a wide array of fashionable finishes to cool and accentuate a space in style. Its integrated warm-dim LED and DC motor technology deliver excellent energy efficiency. Artiste is so versatile; it can be used for both indoor and outdoor spaces.



900172FBN-LWD
BRUSHED NICKEL
WITH SILVER BLADES

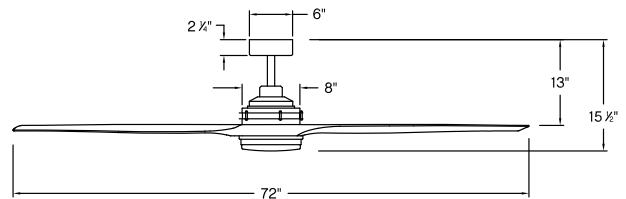

72" ARTISTE™

900172FBN-LWD - BRUSHED NICKEL

900172FGT-LWD - GRAPHITE

900172FMM-LWD - METALLIC MATTE BRONZE

900172FMW-LWD - MATTE WHITE

BLADES:

- 3 Composite Blades Included
- 14° Blade Pitch
- 72" Blade Sweep

MOUNTING:

- 6" Downrod Included
- 76" Lead Wire
- 19.56 lbs. Hanging Weight
- Mounts to Sloped Ceilings
- Up to 20° Pitch

Slope ceiling kit required for ceiling pitch greater than 20°, 992001FXX, see page 146.

LAMPING / GLASS:

- 16w LED Included
- 1320 Lumens | 90 CRI | 3000K
- Dimmable - Warm Dim
- Etched Opal Glass

INCLUDED CONTROLS:

980014FWH-R
6 Speed HIRO Reversing



 Includes WiFi Enabled Control



900172FGT-LWD
 GRAPHITE WITH
 DRIFTWOOD BLADES



932001XX
 Light Kit Cover
 Accessory



900172FMW-LWD
 MATTE WHITE WITH
 MATTE WHITE BLADES



900172FMM-LWD
 METALLIC MATTE BRONZE
 WITH WALNUT BLADES

PERFORMANCE SPECIFICATIONS	STANDARD	
	HIGH SPEED	AVG SPEED
AIRFLOW (CFM)	8957	6124
ENERGY USE (WATTS)	29.5	18
AIRFLOW EFFICIENCY (CFM/W)	303	336
ENERGY COSTS (YEARLY)	\$8.00	\$5.00
AMPS	0.4	0.23
RPMS	125	85

54" TIER™

Classic yet clean, the transitional Tier ties perfectly into any space while delivering superior performance. Tier's array of finish options, including Appliance White, Brushed Nickel, Matte Black and Metallic Matte Bronze, can complement any environment. Equipped with integrated LED technology, Tier delivers excellent energy efficiency. Tier is so versatile, it can be used for both indoor and outdoor spaces.



902054FAW-LWA
APPLIANCE WHITE WITH BRUSHED NICKEL
ACCENTS AND APPLIANCE WHITE BLADES

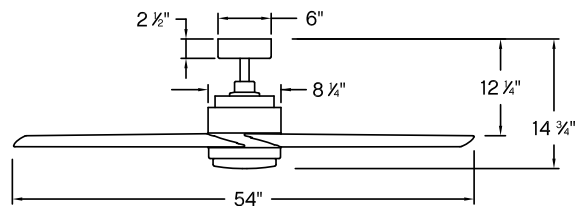

54" TIER™

902054FAW-LWA - APPLIANCE WHITE

902054FBN-LWA - BRUSHED NICKEL

902054FMB-LWA - MATTE BLACK

902054FMM-LWA - METALLIC MATTE BRONZE

BLADES:

- 5 Composite Blades Included
- 14° Blade Pitch
- 54" Blade Sweep

MOUNTING:

- 4.5" Downrod Included
- 76" Lead Wire
- 23.83 lbs. Hanging Weight
- Mounts to Sloped Ceilings
- Up to 25° Pitch

Slope ceiling kit required for ceiling pitch greater than 25°, 992001FXX, see page 146.

LAMPING / GLASS:

- 16w LED Included
- 1500 Lumens | 90 CRI | 3000K
- Dimmable
- Etched Opal Glass

INCLUDED CONTROLS:

- 980014FWH**
3 Speed HIRO Non Reversing
- Manual Reverse





902054FBN-LWA
BRUSHED NICKEL WITH
SILVER BLADES



932020FXX
Light Kit Cover
Accessory



902054FMB-LWA
MATTE BLACK WITH BRUSHED NICKEL
ACCENTS AND MATTE BLACK BLADES



902054FMM-LWA
METALLIC MATTE BRONZE WITH
METALLIC MATTE BRONZE BLADES

OPTIONAL CONTROLS:



CNW902054
Optional WiFi Enabled Control



PERFORMANCE SPECIFICATIONS	STANDARD	
	HIGH SPEED	AVG SPEED
AIRFLOW (CFM)	5664	3749
ENERGY USE (WATTS)	62.8	40
AIRFLOW EFFICIENCY (CFM/W)	90	94
ENERGY COSTS (YEARLY)	\$18.00	\$11.00
AMPS	0.52	0.39
RPMS	155	103

52" VERGE™

The bold silhouette of Verge combines form and function to deliver performance in style. Its minimalist blade design ensures maximum air performance while contemporary classic finish options like Brushed Nickel, Matte Black, Metallic Matte Bronze and Matte White, add a subtle modern edge. Verge comes equipped with integrated LED technology to deliver excellent energy efficiency. Designed for versatility, Verge can be used for both indoor and outdoor spaces.



902352FMB-LWA
MATTE BLACK WITH BRUSHED NICKEL
ACCENTS AND MATTE BLACK BLADES

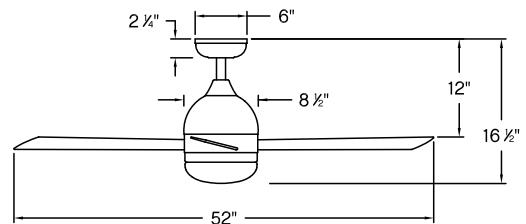

52" VERGE™

902352FBN-LWA - BRUSHED NICKEL

902352FMB-LWA - MATTE BLACK

902352FMM-LWA - METALLIC MATTE BRONZE

902352FMW-LWA - MATTE WHITE

BLADES:

- 3 Composite Blades Included
- 20° Blade Pitch
- 52" Blade Sweep

MOUNTING:

- 4.5" Downrod Included
- 76" Lead Wire
- 16.67 lbs. Hanging Weight
- Mounts to Sloped Ceilings
- Up to 20° Pitch

Slope ceiling kit required for ceiling pitch greater than 20°, 992001FXX, see page 146.

LAMPING / GLASS:

- 16w LED Included
- 1500 Lumens | 90 CRI | 3000K
- Dimmable
- Etched Opal Glass

INCLUDED CONTROLS:

980014FWH

3 Speed HIRO Non Reversing

- Manual Reverse



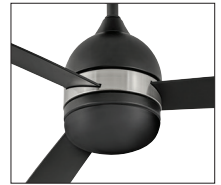

932023FXX
Light Kit Cover
Accessory



902352FBN-LWA
BRUSHED NICKEL WITH
SILVER BLADES



902352FMW-LWA
MATTE WHITE WITH BRUSHED NICKEL
ACCENTS AND MATTE WHITE BLADES



902352FMM-LWA
METALLIC MATTE BRONZE WITH
METALLIC MATTE BRONZE BLADES

OPTIONAL CONTROLS:



CNW902352
Optional WiFi Enabled Control



PERFORMANCE SPECIFICATIONS	STANDARD	
	HIGH SPEED	AVG SPEED
AIRFLOW (CFM)	5226	3642
ENERGY USE (WATTS)	52.4	32.8
AIRFLOW EFFICIENCY (CFM/W)	100	111
ENERGY COSTS (YEARLY)	\$15.00	\$9.00
AMPS	0.44	0.31
RPMS	167	115

60" BIMINI™

Inspired by the small Caribbean island which bears its name, the unique design of Bimini paired with its Appliance White, Brushed Nickel and Metallic Matte Bronze finish options complements any indoor or outdoor space. Supreme air movement is achieved with Bimini's powerful motor.

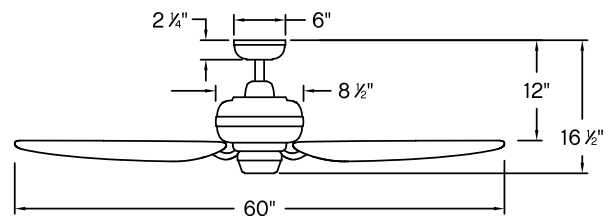

60" BIMINI™

900260FAW-NWA - APPLIANCE WHITE

900260FBN-NWA - BRUSHED NICKEL

900260FMM-NWA - METALLIC MATTE BRONZE

BLADES:

- 3 Composite Blades Included
- 14° Blade Pitch
- 60" Blade Sweep

MOUNTING:

- 4.5" Downrod Included
- 76" Lead Wire
- 24.74 lbs. Hanging Weight
- Mounts to Sloped Ceilings
 - Up to 23° Pitch

Slope ceiling kit required for ceiling pitch greater than 23°, 992001FXX, see page 146.

INCLUDED CONTROLS:

980014FWH

3 Speed HIRO Non Reversing

- Manual Reverse





900260FBN-NWA
BRUSHED NICKEL WITH
WEATHERED WOOD BLADES

OPTIONAL ACCESSORIES:

See pages 144-146 for additional accessories and specifications.



930008FXX
Light Kit Schoolhouse



900260FMM-NWA
METALLIC MATTE BRONZE WITH
METALLIC MATTE BRONZE BLADES

OPTIONAL CONTROLS:



CNW900260
Optional WiFi Enabled Control



PERFORMANCE SPECIFICATIONS	STANDARD	
	HIGH SPEED	AVG SPEED
AIRFLOW (CFM)	5902	4118
ENERGY USE (WATTS)	61.2	39.4
AIRFLOW EFFICIENCY (CFM/W)	96	105
ENERGY COSTS (YEARLY)	\$17.00	\$11.00
AMPS	0.53	0.39
RPMS	150	102

44" TREY™

Trey features a sleek flush mount design that packs a powerful punch. Its transitional style comes equipped with robust blades that seamlessly pair performance and precision. Trey is offered in versatile Brushed Nickel, Metallic Matte Bronze and Matte White finish options, and its integrated LED and DC motor technology deliver excellent energy efficiency. A timeless etched opal glass completes the look for a refined appearance. Trey is so versatile; it can be used for both indoor and outdoor spaces.



902744FBN-LWD
BRUSHED NICKEL WITH
SILVER BLADES

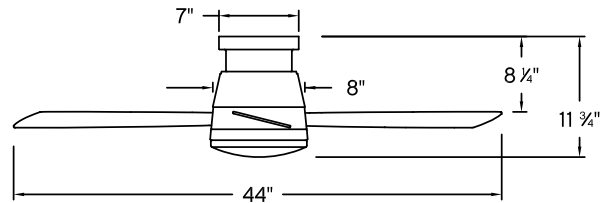

44" TREY™

902744FBN-LWD - BRUSHED NICKEL

902744FMM-LWD - METALLIC MATTE BRONZE

902744FMW-LWD - MATTE WHITE

BLADES:

- 3 Composite Blades Included
- 14° Blade Pitch
- 44" Blade Sweep

MOUNTING:

- 8" Lead Wire
- 14.82 lbs. Hanging Weight

LAMPING / GLASS:

- 16w LED Included
- 1500 Lumens | 90 CRI | 3000K
- Dimmable
- Etched Opal Glass

INCLUDED CONTROLS:

980014FWH-R
6 Speed HIRO Reversing



 Includes WiFi Enabled Control



932027FXX
Light Kit Cover
Accessory



902744FMW-LWD
MATTE WHITE WITH
MATTE WHITE BLADES



902744FMM-LWD
METALLIC MATTE BRONZE WITH
METALLIC MATTE BRONZE BLADES

PERFORMANCE SPECIFICATIONS	STANDARD	
	HIGH SPEED	AVG SPEED
AIRFLOW (CFM)	4842	2918
ENERGY USE (WATTS)	31.6	19
AIRFLOW EFFICIENCY (CFM/W)	152	154
ENERGY COSTS (YEARLY)	\$9.00	\$5.00
AMPS	0.43	0.24
RPMS	260	153

52" TREY™

Trey features a sleek flush mount design that packs a powerful punch. Its transitional style comes equipped with robust blades that seamlessly pair performance and precision. Trey is offered in versatile Brushed Nickel, Metallic Matte Bronze and Matte White finish options, and its integrated LED and DC motor technology deliver excellent energy efficiency. A timeless etched opal glass completes the look for a refined appearance. Trey is so versatile; it can be used for both indoor and outdoor spaces.



902752FBN-LWD
BRUSHED NICKEL WITH
SILVER BLADES

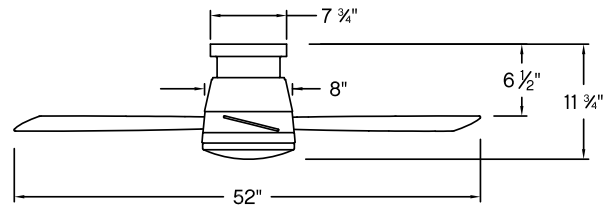

52" TREY™

902752FBN-LWD - BRUSHED NICKEL

902752FMM-LWD - METALLIC MATTE BRONZE

902752FMW-LWD - MATTE WHITE

BLADES:

- 3 Composite Blades Included
- 20° Blade Pitch
- 52" Blade Sweep

MOUNTING:

- 8" Lead Wire
- 24.5 lbs. Hanging Weight

LAMPING / GLASS:

- 16w LED Included
- 1500 Lumens | 90 CRI | 3000K
- Dimmable
- Etched Opal Glass

INCLUDED CONTROLS:

980014FWH-R
6 Speed HIRO Reversing



 Includes WiFi Enabled Control



932027FXX
Light Kit Cover
Accessory



902752FMW-LWD
MATTE WHITE WITH
MATTE WHITE BLADES



902752FMM-LWD
METALLIC MATTE BRONZE WITH
METALLIC MATTE BRONZE BLADES

PERFORMANCE SPECIFICATIONS	STANDARD	
	HIGH SPEED	AVG SPEED
AIRFLOW (CFM)	4827	3120
ENERGY USE (WATTS)	24.2	15
AIRFLOW EFFICIENCY (CFM/W)	200	205
ENERGY COSTS (YEARLY)	\$7.00	\$4.00
AMPS	0.33	0.19
RPMS	169	108

44" VENTUS™

Ventus is the ultimate transitional style guaranteed to cool and complement any interior space. Unique and reversible blades are constructed to ensure maximum performance, while its stylish Metallic Matte Bronze, Matte White and Pewter finish options deliver a sophisticated appearance. Ventus is equipped with integrated LED technology to deliver excellent energy efficiency.



902844FMW-LIA
 MATTE WHITE WITH REVERSIBLE
 MATTE WHITE / WEATHERED WOOD BLADES

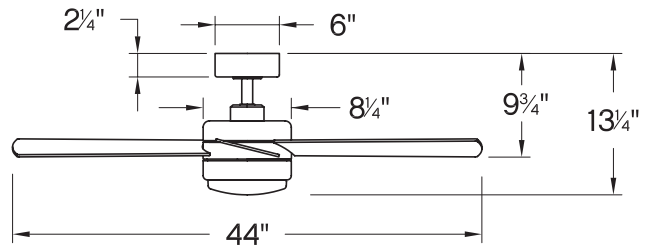

44" VENTUS™

902844FMM-LIA - METALLIC MATTE BRONZE

902844FMW-LIA - MATTE WHITE

902844FPW-LIA - PEWTER

BLADES:

- 3 Wood Blades Included
- 14° Blade Pitch
- 44" Blade Sweep

MOUNTING:

- 4.5" Downrod Included
- 76" Lead Wire
- 19.75 lbs. Hanging Weight
- Mounts to Sloped Ceilings
 - Up to 20° Pitch

Slope ceiling kit required for ceiling pitch greater than 20°, 992001FXX, refer to XX.

LAMPING / GLASS:

- 16w LED Included
- 1500 Lumens | 90 CRI | 3000K
- Dimmable
- Etched Opal Glass

INCLUDED CONTROLS:

- 980014FWH**
 3 Speed HIRO Non Reversing
- Manual Reverse





902844FMM-LIA
 METALLIC MATTE BRONZE WITH REVERSIBLE
 METALLIC MATTE BRONZE / WALNUT BLADES



902844FPW-LIA
 PEWTER WITH REVERSIBLE
 DRIFTWOOD / TEAK BLADES



932028FXX
 Light Kit Cover
 Accessory

REVERSIBLE BLADES:

-  **MATTE WHITE**
 Matte White /
 Weathered Wood
-  **METALLIC MATTE
 BRONZE**
 Metallic Matte Bronze /
 Walnut
-  **PEWTER**
 Driftwood / Teak

OPTIONAL CONTROLS:



CNW902844
 Optional WiFi Enabled Control



PERFORMANCE SPECIFICATIONS	STANDARD	
	HIGH SPEED	AVG SPEED
AIRFLOW (CFM)	3604	2732
ENERGY USE (WATTS)	56.7	38
AIRFLOW EFFICIENCY (CFM/W)	64	71
ENERGY COSTS (YEARLY)	\$16.00	\$11.00
AMPS	0.48	0.39
RPMS	196	146

52" VENTUS™

Ventus is the ultimate transitional style guaranteed to cool and complement any interior space. Unique and reversible blades are constructed to ensure maximum performance, while its stylish Metallic Matte Bronze, Matte White and Pewter finish options deliver a sophisticated appearance. Ventus is equipped with integrated LED technology to deliver excellent energy efficiency.



902852FMW-LIA
 MATTE WHITE WITH REVERSIBLE
 MATTE WHITE / WEATHERED WOOD BLADES

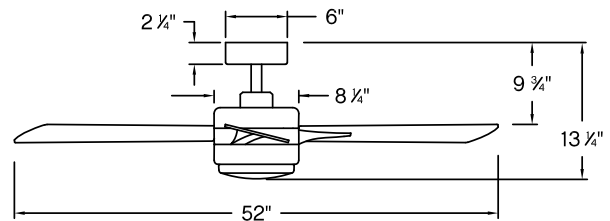

52" VENTUS™

902852FMM-LIA - METALLIC MATTE BRONZE

902852FMW-LIA - MATTE WHITE

902852FPW-LIA - PEWTER

BLADES:

- 3 Wood Blades Included
- 14° Blade Pitch
- 52" Blade Sweep

MOUNTING:

- 4.5" Downrod Included
- 76" Lead Wire
- 20 lbs. Hanging Weight
- Mounts to Sloped Ceilings
- Up to 20° Pitch

Slope ceiling kit required for ceiling pitch greater than 20°, 992001FXX, see page 146.

LAMPING / GLASS:

- 16w LED Included
- 1500 Lumens | 90 CRI | 3000K
- Dimmable
- Etched Opal Glass

INCLUDED CONTROLS:

- 980014FWH**
 3 Speed HIRO Non Reversing
- Manual Reverse





932028FXX
Light Kit Cover
Accessory





902852FMM-LIA
METALLIC MATTE BRONZE WITH REVERSIBLE
METALLIC MATTE BRONZE / WALNUT BLADES



902852FPW-LIA
PEWTER WITH REVERSIBLE
DRIFTWOOD / TEAK BLADES

REVERSIBLE BLADES:

- 
MATTE WHITE
Matte White /
Weathered Wood
- 
METALLIC MATTE BRONZE
Metallic Matte Bronze /
Walnut
- 
PEWTER
Driftwood / Teak

OPTIONAL CONTROLS:



CNW902852
Optional WiFi Enabled Control



PERFORMANCE SPECIFICATIONS	STANDARD	
	HIGH SPEED	AVG SPEED
AIRFLOW (CFM)	4779	3551
ENERGY USE (WATTS)	50.3	33.5
AIRFLOW EFFICIENCY (CFM/W)	95	105
ENERGY COSTS (YEARLY)	\$14.00	\$9.00
AMPS	0.42	0.32
RPMS	187	124

52" TROPIC AIR™

Tropic Air offers a bold, streamlined silhouette with a coastal edge. Available in Metallic Matte Bronze, Graphite, Matte White or Matte Black, its unique design has powerful DC motor technology to deliver excellent energy efficiency. Tropic Air is so versatile; it can be used for both indoor and outdoor spaces.



901952FMW-NWD
MATTE WHITE WITH
WEATHERED WOOD BLADES

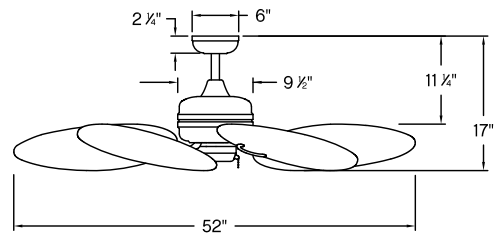

52" TROPIC AIR™

901952FGT-NWD - GRAPHITE

901952FMB-NWD - MATTE BLACK

901952FMM-NWD - METALLIC MATTE BRONZE

901952FMW-NWD - MATTE WHITE

BLADES:

- 5 Composite Blades Included
- 20° Blade Pitch
- 52" Blade Sweep

MOUNTING:

- 6" Downrod Included
- 76" Lead Wire
- 20.7 lbs. Hanging Weight
- Mounts to Sloped Ceilings
 - Up to 33° Pitch

Slope ceiling kit required for ceiling pitch greater than 33°, 992001FXX, see page 146.

INCLUDED CONTROLS:

- Pull Chain
- 4 Speed Manual Reverse



901952FMB-NWD
MATTE BLACK WITH
KOA BLADES



901952FGT-NWD
GRAPHITE WITH
DRIFTWOOD BLADES



901952FMM-NWD
METALLIC MATTE BRONZE WITH
WALNUT BLADES

OPTIONAL ACCESSORIES:

See pages 144-146 for additional accessories and specifications.



930008FXX
Light Kit Schoolhouse



930006FXX
Light Kit Low Profile



930007FXX
Light Kit Heirloom Glass

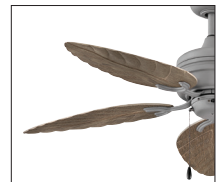

910452FXX
Accessory Blades

OPTIONAL CONTROLS:



980016FWH-019
WiFi HIRO Remote Control
Accessory



PERFORMANCE SPECIFICATIONS	STANDARD	
	HIGH SPEED	AVG SPEED
AIRFLOW (CFM)	6345	4523
ENERGY USE (WATTS)	29.9	19.5
AIRFLOW EFFICIENCY (CFM/W)	212	232
ENERGY COSTS (YEARLY)	\$8.00	\$5.00
AMPS	0.39	0.24
RPMS	141	97

FANDELIER FANDOM

Introducing the **Fandelier**: an innovative new style that brings together the best of both worlds. Part fan, part chandelier – this **dynamic duo** combines cooling comfort with stylish lighting.

These fantastic fixtures not only beautifully marry **form and function** but also come in a variety of **styles and sizes** to complement a myriad of spaces and décor.

Fandeliers are a gamechanger for hardworking, high traffic areas like mudrooms and bathrooms as well as the perfect high-style statement in home offices and bedrooms. On-trend silhouettes, rich finishes and unique materials bring these fandeliers to a new level of cool.

We've combined our forward-thinking approach to product and steadfast promise of quality with 100 years of thoughtful design to deliver superior fan styles made for today's smart homes.

Take a spin through our newest fandeliers!



27" BRYCE FANDELIER™

Bryce boasts industrial and rustic elements, which marry together in a winning combination — deeming this the ultimate transitional piece for any home. Available in Matte Black with a Driftwood accent, Brushed Nickel with a Weathered Wood accent or Heritage Brass with a Matte Black accent, your design options are vast and versatile.



904627FBN-LIA
BRUSHED NICKEL WITH WEATHERED WOOD
ACCENTS AND SILVER BLADES

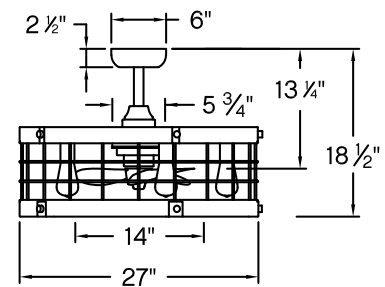

DESCRIPTION

904627FBN-LIA - BRUSHED NICKEL

904627FHB-LIA - HERITAGE BRASS

904627FMB-LIA - MATTE BLACK

BLADES:

- 3 Composite Blades Included
- 20° Blade Pitch
- 14" Blade Sweep

MOUNTING:

- 6" Downrod Included
- 76" Lead Wire
- 22.42 lbs. Hanging Weight
- Mounts to Sloped Ceilings
- Up to 20° Pitch

Slope ceiling kit required for ceiling pitch greater than 20°, 992001FXX, see page 146.

LAMPING:

- 5-6w Med. LED Included
- 2500 Lumens | 90 CRI | 2700K
- Dimmable

INCLUDED CONTROLS:

- 980014FWH**
3 Speed HIRO Non Reversing
- Manual Reverse



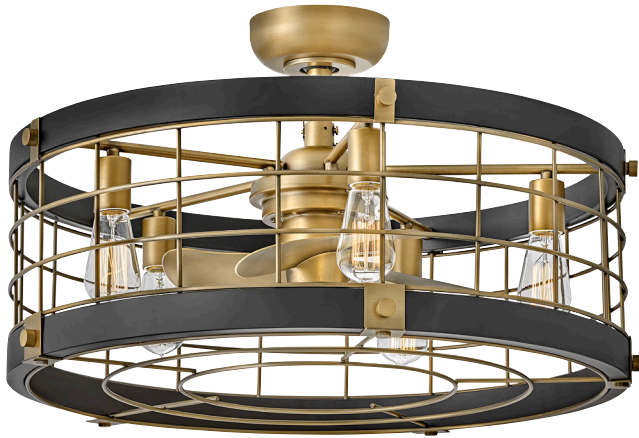

904627FHB-LIA
HERITAGE BRASS WITH MATTE BLACK
ACCENTS AND HERITAGE BRASS BLADES



904627FMB-LIA
MATTE BLACK WITH DRIFTWOOD
ACCENTS AND MATTE BLACK BLADES

OPTIONAL CONTROLS:



CNW904627
Optional WiFi Enabled Control



See hinkley.com for performance data.

22" ELI FANDELIER™

Eli is an instant favorite with unique design elements and modern edge. Available in Brushed Nickel with Matte Black accent, Heritage Brass with Matte Black accent, or Matte Black with Driftwood accent, this Fandelier adds an industrial-hip character to any indoor space.

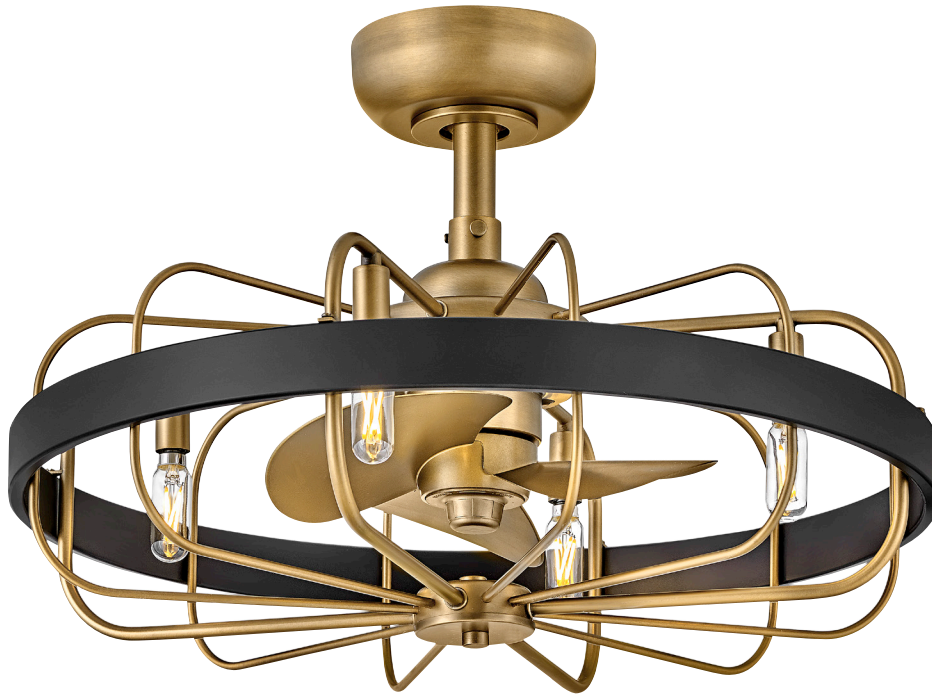

905022FHB-LIA
HERITAGE BRASS WITH MATTE BLACK
ACCENTS AND HERITAGE BRASS BLADES

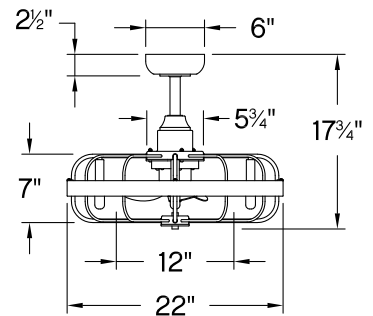

DESCRIPTION

905022FBN-LIA - BRUSHED NICKEL

905022FHB-LIA - HERITAGE BRASS

905022FMB-LIA - MATTE BLACK

BLADES:

- 3 Composite Blades Included
- 20° Blade Pitch
- 12" Blade Sweep

MOUNTING:

- 6" Downrod Included
- 76" Lead Wire
- 12.08 lbs. Hanging Weight
- Mounts to Sloped Ceilings
- Up to 20° Pitch

Slope ceiling kit required for ceiling pitch greater than 20°, 992001FXX, see page 146.

LAMPING:

- 4-4.5w Cand. LED Included
- 1200 Lumens | 90 CRI | 2700K
- Dimmable

INCLUDED CONTROLS:

- 980014FWH
- 3 Speed HIRO Non Reversing
- Manual Reverse





905022FBN-LIA
BRUSHED NICKEL WITH MATTE BLACK
ACCENTS AND SILVER BLADES



905022FMB-LIA
MATTE BLACK WITH DRIFTWOOD
ACCENTS AND MATTE BLACK BLADES

OPTIONAL CONTROLS:



CNW905022
Optional WiFi Enabled Control



See hinkley.com for performance data.

24" FINNIGAN FANDELIER™

Finnigan makes an immediate statement in any interior. Its sleek, Matte Black finish boasts timeless flair, while its unique cage adds just the right amount of industrial panache. Finnigan brings a sophisticated touch to all decors while maintaining its function.



904724FMB-LIA
 MATTE BLACK FINISH
 MATTE BLACK BLADES

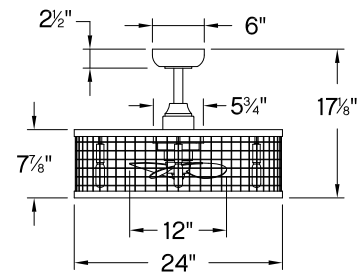

24" FINNIGAN™

904724FMB-LIA - MATTE BLACK

30" FINNIGAN™

904730FMB-LIA - MATTE BLACK

BLADES:

- 3 Composite Blades Included
- 20° Blade Pitch
- 904724FMB-LIA - 12" Blade Sweep
- 904730FMB-LIA - 14" Blade Sweep

MOUNTING:

- 6" Downrod Included
- 76" Lead Wire
- 904724FMB-LIA - 9.9 lbs. Hanging Weight
- 904730FMB-LIA - 12.72 lbs. Hanging Weight
- Mounts to Sloped Ceilings
 - Up to 20° Pitch

Slope ceiling kit required for ceiling pitch greater than 20°, 992001FXX, see page 146.

LAMPING:

904724FMB-LIA

- 4-4.5w Cand. LED Included
- 1200 Lumens | 90 CRI | 2700K
- Dimmable

904730FMB-LIA

- 6-4.5w Cand. LED Included
- 1800 Lumens | 90 CRI | 2700K
- Dimmable

30" FINNIGAN™



904730FMB-LIA
MATTE BLACK WITH
MATTE BLACK BLADES

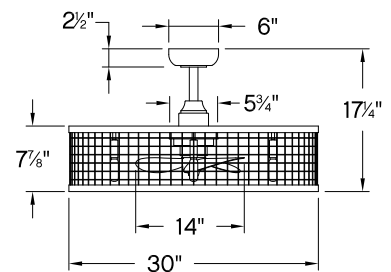

INCLUDED CONTROLS:

980014FWH

3 Speed HIRO Non Reversing

- Manual Reverse



OPTIONAL CONTROLS:



904724FMB-LIA

- CNW904724

Optional WiFi Enabled Control



904730FMB-LIA

- CNW904730

Optional WiFi Enabled Control



See hinkley.com for performance data.

36" SAWYER FANDELIER™

The fresh, rustic design of Sawyer will inject any outdoor living experience with the warm, cozy ambiance of an indoor setting. Available in Metallic Matte Bronze with Sequoia, Matte White with Weathered Wood or Matte Black with Driftwood, Sawyer features composite blades. Sawyer is so versatile; it can be used for both indoor and outdoor spaces.



902928FMM-LWD
METALLIC MATTE BRONZE WITH SEQUOIA
ACCENTS AND SEQUOIA BLADES

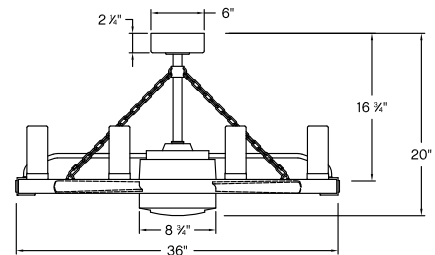

36" SAWYER™ WITH 28" FAN

902928FMB-LWD - MATTE BLACK

902928FMM-LWD - METALLIC MATTE BRONZE

902928FMW-LWD - MATTE WHITE

BLADES:

- 5 Composite Blades Included
- 16° Blade Pitch
- 28" Blade Sweep

MOUNTING:

- 12" & 24" Downrod Included
- 76" Lead Wire
- 30 lbs. Hanging Weight
- Mounts to Sloped Ceilings
- Up to 20° Pitch

Slope ceiling kit required for ceiling pitch greater than 20°, 992001FXX, see page 146.

LAMPING / GLASS:

- 8-4w Cand. LED Included
- 2840 Lumens | 90 CRI | 3000K
- Dimmable
- Clear Seedy Glass

INCLUDED CONTROLS:

980014FWH-R
6 Speed HIRO Reversing



- Includes WiFi Enabled Control



902928FMW-LWD
 MATTE WHITE WITH WEATHERED WOOD ACCENTS
 AND WEATHERED WOOD BLADES



902928FMB-LWD
 MATTE BLACK WITH DRIFTWOOD
 ACCENTS AND DRIFTWOOD BLADES

PERFORMANCE SPECIFICATIONS	STANDARD	
	HIGH SPEED	AVG SPEED
AIRFLOW (CFM)	2432	1637
ENERGY USE (WATTS)	10.7	8
AIRFLOW EFFICIENCY (CFM/W)	227	201
ENERGY COSTS (YEARLY)	\$3.00	\$2.00
AMPS	0.19	0.12
RPMS	319	211



REGENCY SERIES

The Regency Series offers all purpose, affordable ceiling fans that can enhance a variety of spaces.

52" AFTON	116	52" HIGHLAND	124	52" METRO	136
36" CABANA	132	52" HIGHLAND ILLUMINATED	122	52" METRO ILLUMINATED	134
42" CROFT	110	52" HIGHLAND WET	126	52" METRO WET	138
52" CROFT	112	60" HIGHLAND	128	52" OASIS	118
60" CROFT	114	60" HIGHLAND WET	130	60" OASIS	120

[EXPLORE THE REGENCY SERIES >](#)

42" CROFT™

Croft features a clean and modern design, but maintains its traditional feel featuring pull chain functionality and a high-quality LED light kit. Offered in three sizes in an array of finishes and blades, Croft is designed to suit any décor.



904042FMB-LIA
MATTE BLACK WITH REVERSIBLE
MATTE BLACK / WALNUT BLADES

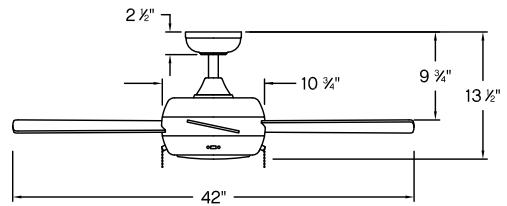

42" CROFT™

904042FBN-LIA - BRUSHED NICKEL

904042FCW-LIA - CHALK WHITE

904042FMB-LIA - MATTE BLACK

904042FMM-LIA - METALLIC MATTE BRONZE

BLADES:

- 5 Wood Blades Included
- 12° Blade Pitch
- 42" Blade Sweep

MOUNTING:

- 4.5" Downrod Included
- 76" Lead Wire
- 14.11 lbs. Hanging Weight
- Mounts to Sloped Ceilings
- Up to 20° Pitch

Slope ceiling kit required for ceiling pitch greater than 20°, 992001FXX, see page 146.

LAMPING / GLASS:

- 16w LED Included
- 1500 Lumens | 90 CRI | 3000K
- Dimmable
- Etched Opal Glass

INCLUDED CONTROLS:

3 Speed Pull Chain
Manual Reverse



904042FMM-LIA
METALLIC MATTE BRONZE WITH REVERSIBLE
WALNUT / METALLIC MATTE BRONZE BLADES



904042FCW-LIA
CHALK WHITE WITH REVERSIBLE
CHALK WHITE / WEATHERED WOOD BLADES



904042FBN-LIA
BRUSHED NICKEL WITH REVERSIBLE
MATTE BLACK / SILVER BLADES

REVERSIBLE BLADES:

BRUSHED NICKEL
Matte Black / Silver

CHALK WHITE
Chalk White /
Weathered Wood

**METALLIC MATTE
BRONZE**
Metallic Matte Bronze /
Walnut

MATTE BLACK
Matte Black / Walnut

OPTIONAL CONTROLS:



980018FWH-0404
WiFi HIRO Remote Control Accessory



PERFORMANCE SPECIFICATIONS	STANDARD	
	HIGH SPEED	AVG SPEED
AIRFLOW (CFM)	3742	2823
ENERGY USE (WATTS)	50.1	33.0
AIRFLOW EFFICIENCY (CFM/W)	74	86
ENERGY COSTS (YEARLY)	\$14.00	\$9.00
AMPS	0.44	0.33
RPMS	200	149

52" CROFT™

Croft features a clean and modern design, but maintains its traditional feel featuring pull chain functionality and a high-quality LED light kit. Offered in three sizes in an array of finishes and blades, Croft is designed to suit any décor.



904052FHB-LIA
HERITAGE BRASS WITH REVERSIBLE
MATTE BLACK / MATTE WHITE BLADES

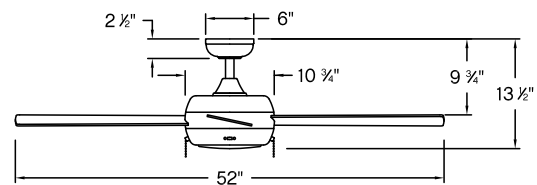

52" CROFT™

904052FBN-LIA - BRUSHED NICKEL

904052FCW-LIA - CHALK WHITE

904052FHB-LIA - HERITAGE BRASS

904052FMB-LIA - MATTE BLACK

904052FMM-LIA - METALLIC MATTE BRONZE

BLADES:

- 5 Wood Blades Included
- 12° Blade Pitch
- 52" Blade Sweep

MOUNTING:

- 4.5" Downrod Included
- 76" Lead Wire
- 16.75 lbs. Hanging Weight
- Mounts to Sloped Ceilings
- Up to 20° Pitch

Slope ceiling kit required for ceiling pitch greater than 20°, 992001FXX, see page 146.

LAMPING / GLASS:

- 16w LED Included
- 1500 Lumens | 90 CRI | 3000K
- Dimmable
- Etched Opal Glass

INCLUDED CONTROLS:

3 Speed Pull Chain
Manual Reverse



904052FMM-LIA
METALLIC MATTE BRONZE WITH REVERSIBLE
METALLIC MATTE BRONZE / WALNUT BLADES



904052FCW-LIA
CHALK WHITE WITH REVERSIBLE
CHALK WHITE / WEATHERED WOOD BLADES



904052FBN-LIA
BRUSHED NICKEL WITH REVERSIBLE
SILVER / MATTE BLACK BLADES



904052FMB-LIA
MATTE BLACK WITH REVERSIBLE
WALNUT / MATTE BLACK BLADES

REVERSIBLE BLADES:

BRUSHED NICKEL
Matte Black / Silver

CHALK WHITE
Chalk White /
Weathered Wood

HERITAGE BRASS
Matte White /
Matte Black

**METALLIC MATTE
BRONZE**
Metallic Matte Bronze /
Walnut

MATTE BLACK
Matte Black / Walnut

OPTIONAL CONTROLS:



980018FWH-0405
WiFi HIRO Remote Control Accessory



PERFORMANCE SPECIFICATIONS	STANDARD	
	HIGH SPEED	AVG SPEED
AIRFLOW (CFM)	5039	3675
ENERGY USE (WATTS)	64.0	41.0
AIRFLOW EFFICIENCY (CFM/W)	79	90
ENERGY COSTS (YEARLY)	\$18.00	\$11.00
AMPS	0.53	0.40
RPMS	158	115

60" CROFT™

Croft features a clean and modern design, but maintains its traditional feel featuring pull chain functionality and a high-quality LED light kit. Offered in three sizes in an array of finishes and blades, Croft is designed to suit any décor.



904060FBN-LIA
BRUSHED NICKEL WITH REVERSIBLE
MATTE BLACK / SILVER BLADES

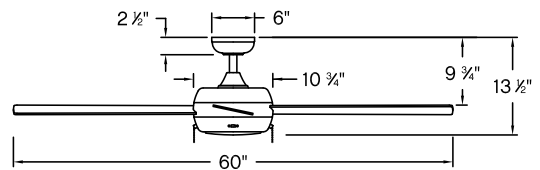

60" CROFT™

904060FBN-LIA - BRUSHED NICKEL

904060FCW-LIA - CHALK WHITE

904060FMB-LIA - MATTE BLACK

904060FMM-LIA - METALLIC MATTE BRONZE

BLADES:

- 5 Wood Blades Included
- 12° Blade Pitch
- 60" Blade Sweep

MOUNTING:

- 4.5" Downrod Included
- 76" Lead Wire
- 20.72 lbs. Hanging Weight
- Mounts to Sloped Ceilings
 - Up to 20° Pitch

Slope ceiling kit required for ceiling pitch greater than 20°, 992001FXX, see page 146.

LAMPING / GLASS:

- 16w LED Included
- 1500 Lumens | 90 CRI | 3000K
- Dimmable
- Etched Opal Glass

INCLUDED CONTROLS:

- 3 Speed Pull Chain
- Manual Reverse



904060FMM-LIA
 METALLIC MATTE BRONZE WITH REVERSIBLE
 METALLIC MATTE BRONZE / WALNUT BLADES



904060FCW-LIA
 CHALK WHITE WITH REVERSIBLE
 WEATHERED WOOD / CHALK WHITE BLADES



904060FMB-LIA
 MATTE BLACK WITH REVERSIBLE
 MATTE BLACK / WALNUT BLADES

REVERSIBLE BLADES:

 **BRUSHED NICKEL**
 Matte Black / Silver

 **CHALK WHITE**
 Chalk White /
 Weathered Wood

 **METALLIC MATTE
 BRONZE**
 Metallic Matte Bronze /
 Walnut

 **MATTE BLACK**
 Matte Black / Walnut

OPTIONAL CONTROLS:



980018FWH-0406
 WiFi HIRO Remote Control Accessory



PERFORMANCE SPECIFICATIONS	STANDARD	
	HIGH SPEED	AVG SPEED
AIRFLOW (CFM)	5787	4054
ENERGY USE (WATTS)	61.2	39.0
AIRFLOW EFFICIENCY (CFM/W)	90	104
ENERGY COSTS (YEARLY)	\$17.00	\$11.00
AMPS	0.54	0.38
RPMS	133	93

52" AFTON™

Clean and modern meets absolute practicality in Afton, making it the ultimate transitional ceiling fan. Afton is available in a robust lineup of finishes, including Chalk White with Chalk White blades, Satin Steel with Matte Black or Silver blades, Matte Black with Matte Black or Silver blades, and Metallic Matte Bronze with Metallic Matte Bronze or Walnut blades. Afton is part of the Regency Collection.



903552FMM-LIA
METALLIC MATTE BRONZE WITH REVERSIBLE
METALLIC MATTE BRONZE / WALNUT BLADES

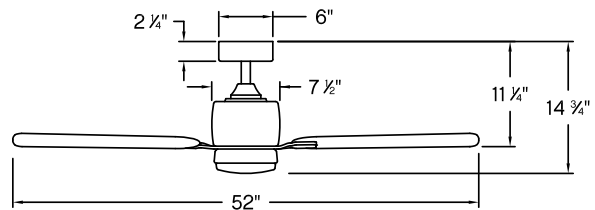

52" AFTON™

903552FCW-LIA - CHALK WHITE

903552FMB-LIA - MATTE BLACK

903552FMM-LIA - METALLIC MATTE BRONZE

903552FSS-LIA - SATIN STEEL

BLADES:

- 5 Wood Blades Included
- 12° Blade Pitch
- 52" Blade Sweep

MOUNTING:

- 4.5" Downrod Included
- 76" Lead Wire
- 18.19 lbs. Hanging Weight
- Mounts to Sloped Ceilings
- Up to 20° Pitch

Slope ceiling kit required for ceiling pitch greater than 20°, 992001FXX, see page 146.

LAMPING / GLASS:

- 16w LED Included
- 1500 Lumens | 90 CRI | 3000K
- Dimmable
- Etched Opal Glass

INCLUDED CONTROLS:

980008FWH
Wall Control Dual Slide
Non-Reversing



REGENCY SERIES



903552FCW-LIA
CHALK WHITE WITH CHALK WHITE BLADES



903552FMB-LIA
MATTE BLACK WITH SILVER ACCENTS AND REVERSIBLE MATTE BLACK / SILVER BLADES



903552FSS-LIA
SATIN STEEL WITH REVERSIBLE MATTE BLACK / SILVER BLADES

OPTIONAL ACCESSORIES:

See pages 144-146 for additional accessories and specifications.

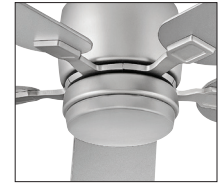

932014FXX
Light Kit Cover

REVERSIBLE BLADES:



MATTE BLACK
Matte Black / Silver



METALLIC MATTE BRONZE
Metallic Matte Bronze / Walnut



SATIN STEEL
Matte Black / Silver

OPTIONAL CONTROLS:



980018FWH-035
WiFi HIRO Remote Control Accessory



PERFORMANCE SPECIFICATIONS	STANDARD	
	HIGH SPEED	AVG SPEED
AIRFLOW (CFM)	5455	3867
ENERGY USE (WATTS)	58.8	36
AIRFLOW EFFICIENCY (CFM/W)	93	106
ENERGY COSTS (YEARLY)	\$16.00	\$10.00
AMPS	0.49	0.35
RPMS	161	111

52" OASIS™

Part of the Regency Series, Oasis offers a simple yet classic all-you-need design, available in Appliance White, Brushed Nickel, Chalk White, Graphite, Matte Black or Metallic Matte Bronze finish options. Oasis is so versatile; it can be used for both indoor and outdoor spaces and the housing and components are constructed of composite materials to offer maximum durability in harsh climates.

DESIGN NOTE

Oasis housing and components are constructed of composite materials to offer maximum durability in harsh climates.



901652FCW-NWA
CHALK WHITE WITH
CHALK WHITE BLADES

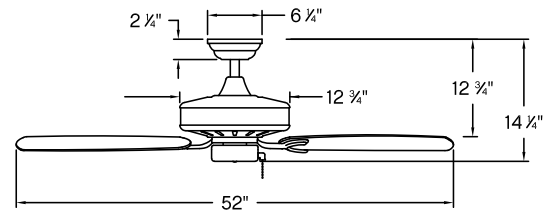

52" OASIS™

901652FAW-NWA - APPLIANCE WHITE

901652FBN-NWA - BRUSHED NICKEL

901652FCW-NWA - CHALK WHITE

901652FGT-NWA - GRAPHITE

901652FMB-NWA - MATTE BLACK

901652FMM-NWA - METALLIC MATTE BRONZE

BLADES:

- 5 Composite Blades Included
- 16° Blade Pitch
- 52" Blade Sweep

MOUNTING:

- 4.5" Downrod Included
- 76" Lead Wire
- 19.5 lbs. Hanging Weight
- Mounts to Sloped Ceilings
 - Up to 26° Pitch

Slope ceiling kit required for ceiling pitch greater than 26°, 992001FXX, see page 146.

INCLUDED CONTROLS:

- 3 Speed Pull Chain
- Manual Reverse



901652FBN-NWA
BRUSHED NICKEL WITH
SILVER BLADES



901652FGT-NWA
GRAPHITE WITH
DRIFTWOOD BLADES



901652FMB-NWA
MATTE BLACK WITH
MATTE BLACK BLADES



901652FMM-NWA
METALLIC MATTE BRONZE WITH
METALLIC MATTE BRONZE BLADES



901652FAW-NWA
APPLIANCE WHITE WITH
APPLIANCE WHITE BLADES

OPTIONAL ACCESSORIES:

See pages 144-146 for additional accessories and specifications.



930006FXX
Light Kit Low Profile



930003FXX
Light Kit Small Low Profile



910452FXX
Accessory Blades

OPTIONAL CONTROLS:



980018FWH-016
WiFi HIRO Remote Control Accessory



PERFORMANCE SPECIFICATIONS	STANDARD	
	HIGH SPEED	AVG SPEED
AIRFLOW (CFM)	5455	3867
ENERGY USE (WATTS)	58.8	36
AIRFLOW EFFICIENCY (CFM/W)	93	106
ENERGY COSTS (YEARLY)	\$16.00	\$10.00
AMPS	0.49	0.35
RPMS	161	111

60" OASIS™

Part of the Regency Series, Oasis offers a simple yet classic all-you-need design, available in Appliance White, Brushed Nickel, Chalk White, Graphite, Matte Black or Metallic Matte Bronze finish options. Oasis is so versatile; it can be used for both indoor and outdoor spaces and the housing and components are constructed of composite materials to offer maximum durability in harsh climates.

DESIGN NOTE

Oasis housing and components are constructed of composite materials to offer maximum durability in harsh climates.



901660FCW-NWA
CHALK WHITE WITH
CHALK WHITE BLADES

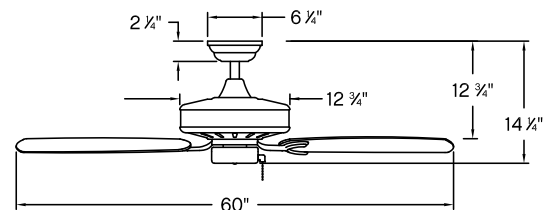

60" OASIS™

901660FBN-NWA - BRUSHED NICKEL

901660FCW-NWA - CHALK WHITE

901660FGT-NWA - GRAPHITE

901660FMB-NWA - MATTE BLACK

901660FMM-NWA - METALLIC MATTE BRONZE

BLADES:

- 5 Composite Blades Included
- 16° Blade Pitch
- 60" Blade Sweep

MOUNTING:

- 4.5" Downrod Included
- 76" Lead Wire
- 26.06lbs. Hanging Weight
- Mounts to Sloped Ceilings
 - Up to 26° Pitch

Slope ceiling kit required for ceiling pitch greater than 26°, 992001FXX, see page 146.

INCLUDED CONTROLS:

- 3 Speed Pull Chain
- Manual Reverse

REGENCY SERIES



901660FBN-NWA
BRUSHED NICKEL WITH
SILVER BLADES



901660FGT-NWA
GRAPHITE WITH
DRIFTWOOD BLADES



901660FMB-NWA
MATTE BLACK WITH
MATTE BLACK BLADES



901660FMM-NWA
METALLIC MATTE BRONZE WITH
METALLIC MATTE BRONZE BLADES

OPTIONAL ACCESSORIES:
See pages 144-146 for additional
accessories and specifications.



930006FXX
Light Kit Low Profile



930003FXX
Light Kit Small Low
Profile



910452FXX
Accessory Blades

OPTIONAL CONTROLS:

 **980018FWH-0166**
WiFi HIRO Remote Control Accessory



PERFORMANCE SPECIFICATIONS	STANDARD	
	HIGH SPEED	AVG SPEED
AIRFLOW (CFM)	5876	4038
ENERGY USE (WATTS)	79.4	48
AIRFLOW EFFICIENCY (CFM/W)	74	84
ENERGY COSTS (YEARLY)	\$22.00	\$13.00
AMPS	0.66	0.46
RPMS	140	96

52" HIGHLAND ILLUMINATED™

Highland Illuminated was designed with versatility in mind. From its practical features to its variety of finish and wooden blade options, this transitional fan will complement any and every space. Highland Illuminated looks sharp in its Metallic Matte Bronze, Brushed Nickel, Chalk White or Matte Black finish options.



904152FBN-LIA
BRUSHED NICKEL WITH REVERSIBLE
SILVER / MAHOGANY BLADES

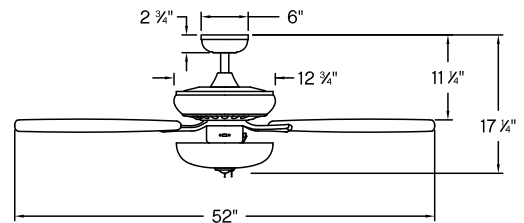

52" HIGHLAND ILLUMINATED™

904152FBN-LIA - BRUSHED NICKEL

904152FCW-LIA - CHALK WHITE

904152FMB-LIA - MATTE BLACK

904152FMM-LIA - METALLIC MATTE BRONZE

BLADES:

- 5 Wood Blades Included
- 13° Blade Pitch
- 52" Blade Sweep

MOUNTING:

- 4.5" Downrod Included
- 76" Lead Wire
- 20.06 lbs. Hanging Weight
- Mounts to Sloped Ceilings
 - Up to 20° Pitch

Slope ceiling kit required for ceiling pitch greater than 20°, 992001FXX, see page 146.

LAMPING / GLASS:

- 3-4w Cand. LED Included
- 1065 Lumens | 90 CRI | 2700K
- Dimmable
- Etched Glass

INCLUDED CONTROLS:

3 Speed Pull Chain
Manual Reverse



904152FCW-LIA
CHALK WHITE WITH REVERSIBLE
CHALK WHITE / WEATHERED WOOD BLADES







904152FMB-LIA
MATTE BLACK WITH REVERSIBLE
MATTE BLACK / WALNUT BLADES



904152FMM-LIA
METALLIC MATTE BRONZE WITH REVERSIBLE
WALNUT / METALLIC MATTE BRONZE BLADES

REVERSIBLE BLADES:

-  **BRUSHED NICKEL**
Silver / Mahogany
-  **CHALK WHITE**
Chalk White /
Weathered Wood
-  **METALLIC MATTE
BRONZE**
Metallic Matte Bronze /
Walnut
-  **MATTE BLACK**
Matte Black / Walnut

OPTIONAL CONTROLS:



980018FWH-415L
WiFi HIRO Remote Control Accessory



PERFORMANCE SPECIFICATIONS	STANDARD	
	HIGH SPEED	AVG SPEED
AIRFLOW (CFM)	5091	3668
ENERGY USE (WATTS)	68.8	44.0
AIRFLOW EFFICIENCY (CFM/W)	74	83
ENERGY COSTS (YEARLY)	\$19.00	\$12.00
AMPS	0.58	0.43
RPMS	157	112

52" HIGHLAND™

Highland was designed with versatility in mind. From its practical features to its variety of finish and wooden blade options, this transitional fan will complement any and every space. Highland is offered in two sizes and looks sharp in its Brushed Nickel, Chalk White, Matte Black or Metallic Matte Bronze finish options.



904152FMM-NIA
METALLIC MATTE BRONZE WITH REVERSIBLE
WALNUT / METALLIC MATTE BRONZE BLADES

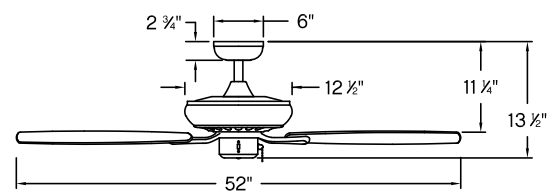

52" HIGHLAND™

904152FBN-NIA - BRUSHED NICKEL

904152FCW-NIA - CHALK WHITE

904152FMB-NIA - MATTE BLACK

904152FMM-NIA - METALLIC MATTE BRONZE

BLADES:

- 5 Wood Blades Included
- 13° Blade Pitch
- 52" Blade Sweep

MOUNTING:

- 4.5" Downrod Included
- 76" Lead Wire
- 17.64 lbs. Hanging Weight
- Mounts to Sloped Ceilings
 - Up to 20° Pitch

Slope ceiling kit required for ceiling pitch greater than 20°, 992001FXX, see page 146.

INCLUDED CONTROLS:

- 3 Speed Pull Chain
- Manual Reverse



904152FCW-NIA
CHALK WHITE WITH REVERSIBLE
WEATHERED WOOD / CHALK WHITE BLADES







904152FBN-NIA
BRUSHED NICKEL WITH REVERSIBLE
MAHOGANY / SILVER BLADES



904152FMB-NIA
MATTE BLACK WITH REVERSIBLE
MATTE BLACK / WALNUT BLADES

REVERSIBLE BLADES:

-  **BRUSHED NICKEL**
Silver / Mahogany
-  **CHALK WHITE**
Chalk White /
Weathered Wood
-  **METALLIC MATTE
BRONZE**
Metallic Matte Bronze /
Walnut
-  **MATTE BLACK**
Matte Black / Walnut

OPTIONAL ACCESSORIES:

See pages 144-146 for additional accessories and specifications.



930001FXX
Light Kit Large
Low Profile



930004FXX
Light Kit Rail Trim



930005FAW-XX
Light Kit White Bowl
with 931001FXX Caps Kit

OPTIONAL CONTROLS:

 **980018FWH-0415**
WiFi HIRO Remote Control Accessory



PERFORMANCE SPECIFICATIONS	STANDARD	
	HIGH SPEED	AVG SPEED
AIRFLOW (CFM)	5136	3721
ENERGY USE (WATTS)	68.7	44.0
AIRFLOW EFFICIENCY (CFM/W)	75	85
ENERGY COSTS (YEARLY)	\$19.00	\$12.00
AMPS	0.58	0.43
RPMS	157	112

52" HIGHLAND WET™

Highland Wet was designed with versatility in mind. From its practical features to its variety of finish options, this transitional fan will complement any and every space. Highland Wet is offered in two sizes and looks sharp in its Metallic Matte Bronze, Brushed Nickel, Chalk White or Matte Black finish options.



904152FMM-NWA
METALLIC MATTE BRONZE
WITH WALNUT BLADES

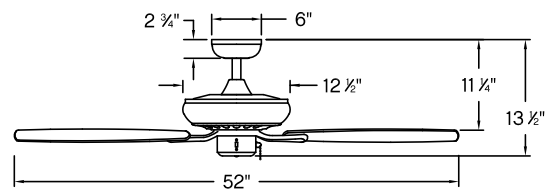

52" HIGHLAND WET™

904152FBN-NWA - BRUSHED NICKEL

904152FCW-NWA - CHALK WHITE

904152FMB-NWA - MATTE BLACK

904152FMM-NWA - METALLIC MATTE BRONZE

BLADES:

- 5 Composite Blades Included
- 13° Blade Pitch
- 52" Blade Sweep

MOUNTING:

- 4.5" Downrod Included
- 76" Lead Wire
- 19.40 lbs. Hanging Weight
- Mounts to Sloped Ceilings
 - Up to 20° Pitch

Slope ceiling kit required for ceiling pitch greater than 20°, 992001FXX, see page 146.

INCLUDED CONTROLS:

- 3 Speed Pull Chain
- Manual Reverse



904152FCW-NWA
CHALK WHITE WITH
WEATHERED WOOD BLADES



904152FBN-NWA
BRUSHED NICKEL
WITH SILVER BLADES



904152FMB-NWA
MATTE BLACK
WITH BIRCH BLADES

OPTIONAL ACCESSORIES:

See pages 144-146 for additional accessories and specifications.



930001FXX
Light Kit Large
Low Profile



930004FXX
Light Kit Rail Trim



930005FAW-XX
Light Kit White Bowl
with 931001FXX Caps Kit

OPTIONAL CONTROLS:



980018FWH-415W

WiFi HIRO Remote Control Accessory



PERFORMANCE SPECIFICATIONS	STANDARD	
	HIGH SPEED	AVG SPEED
AIRFLOW (CFM)	5107	3516
ENERGY USE (WATTS)	61.3	37.0
AIRFLOW EFFICIENCY (CFM/W)	83	95
ENERGY COSTS (YEARLY)	\$17.00	\$10.00
AMPS	0.51	0.36
RPMS	162	112

60" HIGHLAND™

Highland was designed with versatility in mind. From its practical features to its variety of finish and wooden blade options, this transitional fan will complement any and every space. Highland is offered in two sizes and looks sharp in its Brushed Nickel, Chalk White, Matte Black or Metallic Matte Bronze finish options.



904160FBN-NIA
BRUSHED NICKEL WITH REVERSIBLE
SILVER / MAHOGANY BLADES

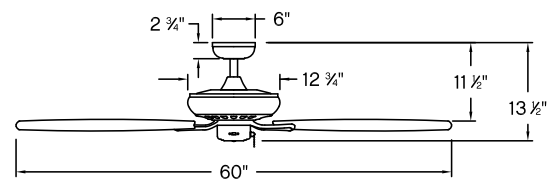

60" HIGHLAND™

904160FBN-NIA - BRUSHED NICKEL

904160FCW-NIA - CHALK WHITE

904160FMB-NIA - MATTE BLACK

904160FMM-NIA - METALLIC MATTE BRONZE

BLADES:

- 5 Wood Blades Included
- 13° Blade Pitch
- 60" Blade Sweep

MOUNTING:

- 4.5" Downrod Included
- 76" Lead Wire
- 22.71 lbs. Hanging Weight
- Mounts to Sloped Ceilings
 - Up to 20° Pitch

Slope ceiling kit required for ceiling pitch greater than 20°, 992001FXX, see page 146.

INCLUDED CONTROLS:

- 3 Speed Pull Chain
- Manual Reverse



904160FCW-NIA
CHALK WHITE WITH REVERSIBLE
WEATHERED WOOD / CHALK WHITE BLADES







904160FMM-NIA
METALLIC MATTE BRONZE WITH REVERSIBLE
WALNUT / METALLIC MATTE BRONZE BLADES



904160FMB-NIA
MATTE BLACK WITH REVERSIBLE
MATTE BLACK / WALNUT BLADES

REVERSIBLE BLADES:

-  **BRUSHED NICKEL**
Silver / Mahogany
-  **CHALK WHITE**
Chalk White /
Weathered Wood
-  **METALLIC MATTE
BRONZE**
Metallic Matte Bronze /
Walnut
-  **MATTE BLACK**
Matte Black / Walnut

OPTIONAL ACCESSORIES:

See pages 144-146 for additional accessories and specifications.



930001FXX
Light Kit Large
Low Profile



930004FXX
Light Kit Rail Trim



930005FAW-XX
Light Kit White Bowl
with 931001FXX Caps Kit

OPTIONAL CONTROLS:



980018FWH-0416
WiFi HIRO Remote
Control Accessory



PERFORMANCE SPECIFICATIONS	STANDARD	
	HIGH SPEED	AVG SPEED
AIRFLOW (CFM)	5982	4077
ENERGY USE (WATTS)	84.3	51.0
AIRFLOW EFFICIENCY (CFM/W)	71	80
ENERGY COSTS (YEARLY)	\$24.00	\$14.00
AMPS	0.71	0.49
RPMS	114	78

60" HIGHLAND WET™

Highland Wet was designed with versatility in mind. From its practical features to its variety of finish options, this transitional fan will complement any and every space. Highland Wet is offered in two sizes and looks sharp in its Metallic Matte Bronze, Brushed Nickel, Chalk White or Matte Black finish options.



904160FMB-NWA
MATTE BLACK
WITH BIRCH BLADES

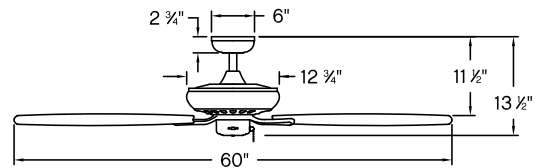

60" HIGHLAND WET™

904160FBN-NWA - BRUSHED NICKEL

904160FCW-NWA - CHALK WHITE

904160FMB-NWA - MATTE BLACK

904160FMM-NWA - METALLIC MATTE BRONZE

BLADES:

- 5 Composite Blades Included
- 13° Blade Pitch
- 60" Blade Sweep

MOUNTING:

- 4.5" Downrod Included
- 76" Lead Wire
- 25.35 lbs. Hanging Weight
- Mounts to Sloped Ceilings
 - Up to 20° Pitch

Slope ceiling kit required for ceiling pitch greater than 20°, 992001FXX, see page 146.

INCLUDED CONTROLS:

- 3 Speed Pull Chain
- Manual Reverse



904160FCW-NWA
CHALK WHITE WITH
WEATHERED WOOD BLADES



904160FBN-NWA
BRUSHED NICKEL
WITH SILVER BLADES



904160FMM-NWA
METALLIC MATTE BRONZE
WITH WALNUT BLADES

OPTIONAL ACCESSORIES:

See pages 144-146 for additional accessories and specifications.



930006FXX
Light Kit Low Profile



930007FXX
Light Kit Heirloom Glass



930008FXX
Light Kit Schoolhouse

OPTIONAL CONTROLS:



980018FWH-0416W

WiFi HIRO Remote Control Accessory



PERFORMANCE SPECIFICATIONS	STANDARD	
	HIGH SPEED	AVG SPEED
AIRFLOW (CFM)	6629	4465
ENERGY USE (WATTS)	82.6	50
AIRFLOW EFFICIENCY (CFM/W)	80	89
ENERGY COSTS (YEARLY)	\$23.00	\$14.00
AMPS	0.69	0.48
RPMS	142	96

36" CABANA™

Part of the Regency Series, the traditional Cabana is a seamless way to enhance the comfort level and enjoyment of any room. Available in Appliance White, Metallic Matte Bronze, Matte Black and Brushed Nickel finish options, it complements spaces of all styles. Cabana achieves powerful air movement and is so versatile it can be used both indoors and outdoors.



Cabana fans mount directly to canopy or with included downrod for dual mount capability.



901836FBN-NWA
BRUSHED NICKEL WITH
WEATHERED WOOD BLADES

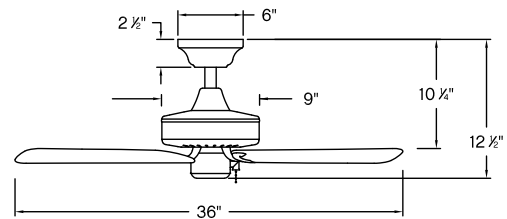

36" CABANA™

901836FAW-NWA - APPLIANCE WHITE

901836FBN-NWA - BRUSHED NICKEL

901836FMB-NWA - MATTE BLACK

901836FMM-NWA - METALLIC MATTE BRONZE

BLADES:

- 5 Composite Blades Included
- 14° Blade Pitch
- 36" Blade Sweep

MOUNTING:

- 4.5" Downrod Included
- 76" Lead Wire
- 11.46 lbs. Hanging Weight
- Mounts to Sloped Ceilings
 - Up to 35° Pitch

Slope ceiling kit required for ceiling pitch greater than 35°, 992001FXX, see page 146.

INCLUDED CONTROLS:

- 3 Speed Pull Chain
- Manual Reverse



901836FAW-NWA
APPLIANCE WHITE WITH
APPLIANCE WHITE BLADES



901836FMB-NWA
MATTE BLACK WITH
WALNUT BLADES



901836FMM-NWA
METALLIC MATTE BRONZE WITH
METALLIC MATTE BRONZE BLADES

OPTIONAL ACCESSORIES:

See pages 144-146 for additional accessories and specifications.



930006FXX
Light Kit Low Profile



930008FXX
Light Kit Schoolhouse

OPTIONAL CONTROLS:



980018FWH-018
WiFi HIRO Remote
Control Accessory



PERFORMANCE SPECIFICATIONS	STANDARD		FLUSH MOUNT	
	HIGH SPEED	AVERAGE	HIGH SPEED	AVERAGE
AIRFLOW (CFM)	3101	2566	2947	2424
ENERGY USE (WATTS)	37.6	26.8	37.7	26.4
AIRFLOW EFFICIENCY (CFM/W)	82	96	78	92
ENERGY COSTS (YEARLY)	\$11.00	\$8.00	\$11.00	\$7.00
AMPS	0.32	0.26	0.32	0.26
RPMS	242	193	242	193

52" METRO™ ILLUMINATED

Metro Illuminated evokes a sense of timeless tradition to interiors of all styles. Metro Illuminated is available in Brushed Nickel with Silver or Matte Black blades, Chalk White with Chalk White or Weathered Wood blades, Matte Black with Matte Black or Walnut blades, and Metallic Matte Bronze with Metallic Matte Bronze or Walnut blades. Metro Illuminated features LED lamps and is part of the Regency Collection.



Metro Illuminated fans mount directly to canopy or with included downrod for dual mount capability.



903352FCW-LIA
CHALK WHITE WITH REVERSIBLE
CHALK WHITE / WEATHERED WOOD BLADES

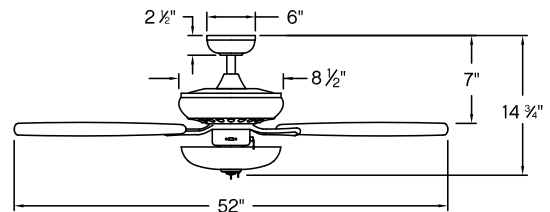

52" METRO™ ILLUMINATED

903352FBN-LIA - BRUSHED NICKEL

903352FCW-LIA - CHALK WHITE

903352FMB-LIA - MATTE BLACK

903352FMM-LIA - METALLIC MATTE BRONZE

BLADES:

- 5 Wood Blades Included
- 13° Blade Pitch
- 52" Blade Sweep

MOUNTING:

- 4.5" Downrod Included
- 76" Lead Wire
- 18.52 lbs. Hanging Weight
- Mounts to Sloped Ceilings
- Up to 20° Pitch

Slope ceiling kit required for ceiling pitch greater than 20°, 992001FXX, see page 146.

LAMPING / GLASS:

- 2-9w Med. LED Included
- 1620 Lumens | 90 CRI | 3000K
- Dimmable
- Etched Opal Glass

INCLUDED CONTROLS:

3 Speed Pull Chain
Manual Reverse



903352FBN-LIA
BRUSHED NICKEL WITH REVERSIBLE
MATTE BLACK / SILVER BLADES



903352FMB-LIA
MATTE BLACK WITH REVERSIBLE
WALNUT / MATTE BLACK BLADES



903352FMM-LIA
METALLIC MATTE BRONZE WITH REVERSIBLE
METALLIC MATTE BRONZE / WALNUT BLADES

REVERSIBLE BLADES:

 **BRUSHED NICKEL**
Matte Black / Silver

 **CHALK WHITE**
Chalk White /
Weathered Wood

 **MATTE BLACK**
Matte Black / Walnut

 **METALLIC MATTE BRONZE**
Metallic Matte Bronze / Walnut

OPTIONAL CONTROLS:



980018FWH-033L
WiFi HIRO Remote
Control Accessory



PERFORMANCE SPECIFICATIONS	STANDARD		FLUSH MOUNT	
	HIGH SPEED	AVERAGE	HIGH SPEED	AVERAGE
AIRFLOW (CFM)	4577	3427	4443	3196
ENERGY USE (WATTS)	58.3	36	61.8	38
AIRFLOW EFFICIENCY (CFM/W)	79	88	71.9	84
ENERGY COSTS (YEARLY)	\$16.00	\$10.00	\$17.00	\$11.00
AMPS	0.50	0.36	0.52	0.38
RPMS	154	105	162	36

52" METRO™

Metro evokes a sense of timeless tradition to interiors of all styles. Metro is available in Brushed Nickel with Silver or Matte Black blades, Chalk White with Chalk White or Weathered Wood blades, Matte Black with Matte Black or Walnut blades, and Metallic Matte Bronze with Metallic Matte Bronze or Walnut blades. Metro is part of the Regency Collection.



Metro fans mount directly to canopy or with included downrod for dual mount capability.



903352FCW-NIA
CHALK WHITE WITH REVERSIBLE
WEATHERED WOOD / CHALK WHITE BLADES

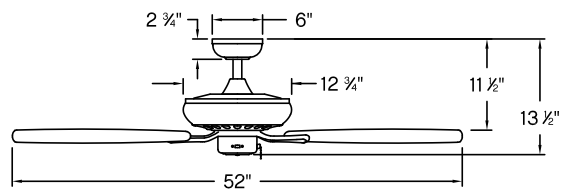

52" METRO™

903352FBN-NIA - BRUSHED NICKEL

903352FCW-NIA - CHALK WHITE

903352FMB-NIA - MATTE BLACK

903352FMM-NIA - METALLIC MATTE BRONZE

BLADES:

- 5 Wood Blades Included
- 13° Blade Pitch
- 52" Blade Sweep

MOUNTING:

- 4.5" Downrod Included
- 76" Lead Wire
- 16 lbs. Hanging Weight
- Mounts to Sloped Ceilings
 - Up to 20° Pitch

Slope ceiling kit required for ceiling pitch greater than 20°, 992001FXX, see page 146.

INCLUDED CONTROLS:

- 3 Speed Pull Chain
- Manual Reverse



903352FBN-NIA
BRUSHED NICKEL WITH REVERSIBLE
SILVER / MATTE BLACK BLADES



903352FMB-NIA
MATTE BLACK WITH REVERSIBLE
MATTE BLACK / WALNUT BLADES



903352FMM-NIA
METALLIC MATTE BRONZE WITH REVERSIBLE
WALNUT / METALLIC MATTE BRONZE BLADES

OPTIONAL ACCESSORIES:

See pages 144-146 for additional accessories and specifications.



930005FAW-XX
Light Kit, Amber Cover



930005FAW-XX
Light Kit, White Cover



930008FXX
Light Kit, Schoolhouse

REVERSIBLE BLADES:

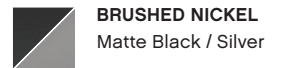

OPTIONAL CONTROLS:



980018FWH-033
WiFi HIRO Remote
Control Accessory



PERFORMANCE SPECIFICATIONS	STANDARD		FLUSH MOUNT	
	HIGH SPEED	AVERAGE	HIGH SPEED	AVERAGE
AIRFLOW (CFM)	4672	3513	4553	3266
ENERGY USE (WATTS)	50.7	35	61.8	38
AIRFLOW EFFICIENCY (CFM/W)	81	90	73.7	86
ENERGY COSTS (YEARLY)	\$16.00	\$10.00	\$17.00	\$11.00
AMPS	0.49	0.35	0.52	0.38
RPMS	154	105	162	36

52" METRO™ WET

The Metro Wet ceiling fan evokes a sense of timeless tradition to indoor and outdoor settings. Composed of Composite blades, Metro is available in Brushed Nickel with Silver blades, Chalk White with Chalk White blades, Matte Black with Matte Black blades, and Metallic Matte Bronze with Walnut blades. Wet-rated, Metro Wet is versatile enough to be used for both indoor and outdoor spaces and is part of the Regency Collection.



Metro Wet fans mount directly to canopy or with included downrod for dual mount capability.



903352FCW-NWA
CHALK WHITE WITH
CHALK WHITE BLADES

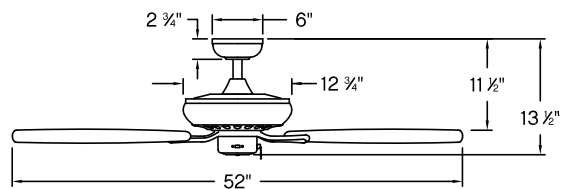

52" METRO™ WET

903352FBN-NWA - BRUSHED NICKEL

903352FCW-NWA - CHALK WHITE

903352FMB-NWA - MATTE BLACK

903352FMM-NWA - METALLIC MATTE BRONZE

BLADES:

- 5 Composite Blades Included
- 13° Blade Pitch
- 52" Blade Sweep

MOUNTING:

- 4.5" Downrod Included
- 76" Lead Wire
- 16 lbs. Hanging Weight
- Mounts to Sloped Ceilings
 - Up to 20° Pitch

Slope ceiling kit required for ceiling pitch greater than 20°, 992001FXX, see page 146.

INCLUDED CONTROLS:

- 3 Speed Pull Chain
- Manual Reverse



903352FBN-NWA
BRUSHED NICKEL WITH
SILVER BLADES



903352FMB-NWA
MATTE BLACK WITH
MATTE BLACK BLADES



903352FMM-NWA
METALLIC MATTE BRONZE
WITH WALNUT BLADES

OPTIONAL ACCESSORIES:

See pages 144-146 for additional accessories and specifications.



930003FXX
Light Kit, Small Low Profile



930008FXX
Light Kit, Schoolhouse

OPTIONAL CONTROLS:



980018FWH-033
WiFi HIRO Remote
Control Accessory



PERFORMANCE SPECIFICATIONS	STANDARD		FLUSH MOUNT	
	HIGH SPEED	AVERAGE	HIGH SPEED	AVERAGE
AIRFLOW (CFM)	4672	3189	4167	2884
ENERGY USE (WATTS)	57.7	35	57.6	35
AIRFLOW EFFICIENCY (CFM/W)	81	90	72.3	82
ENERGY COSTS (YEARLY)	\$16.00	\$10.00	\$16.00	\$10.00
AMPS	0.49	0.35	0.49	0.35
RPMS	154	105	152	34

LED LIGHT KITS



930003FXX - Light Kit Small Low Profile		
	AVAILABLE FINISHES	AW - Appliance White
		BN - Brushed Nickel (shown)
		CW - Chalk White
		GT - Graphite
		MB - Matte Black
		MM - Metallic Matte Bronze
	GLASS	Etched Opal
WIDTH	11" Dia.	
HEIGHT	5"	
LAMPING	16w Integrated LED 1500 Lumens 3000K 90 CRI	

930007FXX - Light Kit Heirloom Glass		
	AVAILABLE FINISHES	AW - Appliance White (shown)
		BN - Brushed Nickel
		CW - Chalk White
		GT - Graphite
		MB - Matte Black
		MM - Metallic Matte Bronze
	GLASS	Etched Opal
WIDTH	10¼" Dia.	
HEIGHT	6¼"	
LAMPING	16w Integrated LED 1500 Lumens 3000K 90 CRI	

930006FXX - Light Kit Low Profile		
	AVAILABLE FINISHES	AW - Appliance White
		BN - Brushed Nickel
		CW - Chalk White
		GT - Graphite
		MB - Matte Black
		MM - Metallic Matte Bronze (shown)
	GLASS	Etched Opal
WIDTH	11" Dia.	
HEIGHT	4½"	
LAMPING	16w Integrated LED 1500 Lumens 3000K 90 CRI	

930008FXX - Light Kit Schoolhouse		
	AVAILABLE FINISHES	AW - Appliance White
		BN - Brushed Nickel
		CW - Chalk White (shown)
		GT - Graphite
		MB - Matte Black
		MM - Metallic Matte Bronze
	GLASS	Etched Opal
WIDTH	8¼" Dia.	
HEIGHT	7"	
LAMPING	1-9w Med. Base LED Lamp Included 810 Lumens 3000K 90 CRI	

930004FXX - Light Kit Rail Trim		
	AVAILABLE FINISHES	AW - Appliance White
		BN - Brushed Nickel
		CW - Chalk White
		GT - Graphite (shown)
		MM - Metallic Matte Bronze
		GLASS
	WIDTH	13½" Dia.
HEIGHT	4¾"	
LAMPING	24w Integrated LED 2400 Lumens 3000K 90 CRI	

930005FAW-WF - Light Kit White Bowl		
930005FAW-AM - Light Kit Amber Bowl		
 <p>930005FAW-WF Light Kit White Bowl</p>	GLASS	White Frosted / Amber Frosted
	WIDTH	11" Dia.
 <p>930005FAW-AM Light Kit Amber Bowl</p>	HEIGHT	4½"
	LAMPING	2-9w Med. Base LED Lamps Included 1620 Lumens 3000K 90 CRI
 <p>931001FXX Caps Kit</p>	AVAILABLE CAPS KITS	931001FAW Appliance White
		931001FBN (shown) Brushed Nickel
		931001FCW Chalk White
		931001FGT Graphite
		931001FMB Matte Black
931001FMM Metallic Matte Bronze		
		931001FMW Matte White

930001FXX - Light Kit Large Low Profile		
	AVAILABLE FINISHES	BN - Brushed Nickel
		MM - Metallic Matte Bronze
		SS - Satin Steel
	GLASS	Etched Opal
	WIDTH	12" Dia.
	HEIGHT	3½"
	LAMPING	24w Integrated LED 2400 Lumens 3000K 90 CRI

LIGHT KIT COVERS

932001FXX - Artiste Light Kit Cover		
	AVAILABLE FINISHES	BN - Brushed Nickel (shown)
		GT - Graphite
		MM - Metallic Matte Bronze
		MW - Matte White
	WIDTH	8½" Dia.
HEIGHT	2"	

932027FXX - Trey Light Kit Cover		
	AVAILABLE FINISHES	BN - Brushed Nickel
		MM - Metallic Matte Bronze (shown)
		MW - Matte White
	WIDTH	9¾" Dia.
	HEIGHT	2¾"

932014FXX - Afton Light Kit Cover		
	AVAILABLE FINISHES	CW - Chalk White
		MB - Matte Black (shown)
		MM - Metallic Matte Bronze
		SS - Stainless Steel
	WIDTH	7" Dia.
HEIGHT	2¼"	

932020FXX - Tier Light Kit Cover		
	AVAILABLE FINISHES	AW - Appliance White (shown)
		BN - Brushed Nickel
		MB - Matte Black
		MM - Metallic Matte Bronze
	MW - Matte White	
WIDTH	7½" Dia.	
HEIGHT	2½"	

932007FXX - Hover and Vail Flush Light Kit Cover		
	AVAILABLE FINISHES	BN - Brushed Nickel
		GT - Graphite (shown)
		MB - Matte Black
		MM - Metallic Matte Bronze
	MW - Matte White	
WIDTH	7" Dia.	
HEIGHT	2"	

932023FXX - Verge Light Kit Cover		
	AVAILABLE FINISHES	BN - Brushed Nickel
		MB - Matte Black
		MM - Metallic Matte Bronze
		MW - Matte White (shown)
	WIDTH	8½" Dia.
HEIGHT	¾"	

932028FXX - Ventus Light Kit Cover		
	AVAILABLE FINISHES	MM - Metallic Matte Bronze
		MW - Matte White
		PW - Pewter (shown)
	WIDTH	7½" Dia.
	HEIGHT	2½"

ACCESSORY BLADES

5 BLADES PER SET
FOR USE WITH OASIS MODELS ONLY



910452FAW
52" Accessory Blade Set
Appliance White | Composite



910452FDR
52" Accessory Blade Set
Driftwood | Composite













910452FMH
52" Accessory Blade Set
Mahogany | Composite

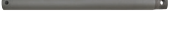

910452FWW
52" Accessory Blade Set
Weathered Wood | Composite

DOWNRODS + MOUNTING ACCESSORIES

AVAILABLE FINISHES		12"	18"	24"	36"	48"	60"	72"
	AW Appliance White	990012FAW 12" Downrod	990018FAW 18" Downrod	990024FAW 24" Downrod	990036FAW 36" Downrod	990048FAW 48" Downrod	990060FAW 60" Downrod	990072FAW 72" Downrod
	BN Brushed Nickel	990012FBN 12" Downrod	990018FBN 18" Downrod	990024FBN 24" Downrod	990036FBN 36" Downrod	990048FBN 48" Downrod	990060FBN 60" Downrod	990072FBN 72" Downrod
	BN-W Brushed Nickel (WET)	990012FBN-W 12" Downrod	990018FBN-W 18" Downrod	990024FBN-W 24" Downrod	990036FBN-W 36" Downrod	990048FBN-W 48" Downrod	990060FBN-W 60" Downrod	990072FBN-W 72" Downrod
	CW Chalk White	990012FCW 12" Downrod	990018FCW 18" Downrod	990024FCW 24" Downrod	990036FCW 36" Downrod	990048FCW 48" Downrod	990060FCW 60" Downrod	990072FCW 72" Downrod
	GT Graphite	990012FGT 12" Downrod	990018FGT 18" Downrod	990024FGT 24" Downrod	990036FGT 36" Downrod	990048FGT 48" Downrod	990060FGT 60" Downrod	990072FGT 72" Downrod
	HB Heritage Brass	990012FHB 12" Downrod	990018FHB 18" Downrod	990024FHB 24" Downrod	990036FHB 36" Downrod	990048FHB 48" Downrod	990060FHB 60" Downrod	990072FHB 72" Downrod
	MB Matte Black	990012FMB 12" Downrod	990018FMB 18" Downrod	990024FMB 24" Downrod	990036FMB 36" Downrod	990048FMB 48" Downrod	990060FMB 60" Downrod	990072FMB 72" Downrod
	MM Metallic Matte Bronze	990012FMM 12" Downrod	990018FMM 18" Downrod	990024FMM 24" Downrod	990036FMM 36" Downrod	990048FMM 48" Downrod	990060FMM 60" Downrod	990072FMM 72" Downrod
	MW Matte White	990012FMW 12" Downrod	990018FMW 18" Downrod	990024FMW 24" Downrod	990036FMW 36" Downrod	990048FMW 48" Downrod	990060FMW 60" Downrod	990072FMW 72" Downrod
	PW Pewter	990012FPW 12" Downrod	990018FPW 18" Downrod	990024FPW 24" Downrod	990036FPW 36" Downrod	990048FPW 48" Downrod	990060FPW 60" Downrod	990072FPW 72" Downrod
	SS Satin Steel	990012FSS 12" Downrod	990018FSS 18" Downrod	990024FSS 24" Downrod	990036FSS 36" Downrod	990048FSS 48" Downrod	990060FSS 60" Downrod	990072FSS 72" Downrod

991001FXX - Downrod Coupler

	AVAILABLE FINISHES	AW - Appliance White
		BN - Brushed Nickel
		CW - Chalk White
		GT - Graphite
		HB - Heritage Brass
		MB - Matte Black
		MM - Metallic Matte Bronze
		MW - Matte White
		PW - Pewter (shown)
		SS - Satin Steel
		WIDTH
	HEIGHT	2"

992001FXX - Slope Ceiling Kit, up to 45°

	AVAILABLE FINISHES	AW - Appliance White
		BN - Brushed Nickel
		CW - Chalk White
		GT - Graphite
		HB - Heritage Brass
		MB - Matte Black
		MM - Metallic Matte Bronze (shown)
		MW - Matte White
		PW - Pewter
		SS - Satin Steel
		WIDTH
	HEIGHT	3 1/4"





WALL CONTROLS - AC MOTOR 3 SPEED FANS

980008FXX - Wall Control 4 Speed Dual Slide		
	AVAILABLE FINISHES	AL - Almond
		WH - White (shown)
	TYPE / FUNCTION	Fan / Light 4 Speed Dual Slide
	AMPS	Max. 1.5
	DIMMING	Full Range
NOTES	Controls one AC fan only. Three wire control. Faceplate included.	

980009FWH - Wall Control 3 Speed, On / Off Switch		
	AVAILABLE FINISH	WH - White
	TYPE / FUNCTION	Fan / Light 3 Speed Slide Control On / Off Light Switch
	AMPS	Max. 1.25
	DIMMING	—
	NOTES	Controls one AC fan only. Three wire control. Faceplate included.

980010FAW - Wall Control 3 Speed Rotary		
	AVAILABLE FINISH	AW - Appliance White
	TYPE / FUNCTION	Fan Only 3 Speed Rotary Control
	AMPS	Max. 1.25
	NOTES	Controls one AC fan only. Faceplate not included.

980011FXX - Wall Control 4 Speed Slide		
	AVAILABLE FINISHES	AL - Almond (shown)
		WH - White
	TYPE / FUNCTION	Fan Only 4 Speed Slide Control
	AMPS	Max. 1.5
NOTES	Controls one AC fan only. Faceplate included.	

980012FWH - Wall Control 3 Speed 5 Amp		
	AVAILABLE FINISH	WH - White
	TYPE / FUNCTION	Fan Only 3 Speed Control Multiple Fans on One Circuit
	AMPS	Max. 5
	NOTES	Controls up to 3 AC fans. Faceplate included.

UNIVERSAL 3 SPEED CONTROL ACCESSORIES

980040FWH - 3 Speed Wall Control (Non-WiFi)		
	AVAILABLE FINISHES	WH - White (shown)
	TYPE / FUNCTION	Fan / Light 3 Speed
	AMPS	—
	DIMMING	—
	NOTES	NON- WiFi

980045FWH - 3 Speed Wall Control (Non-WiFi)		
	AVAILABLE FINISHES	AS - White (shown)
	TYPE / FUNCTION	Fan / Light 3 Speed
	AMPS	—
	DIMMING	—
	NOTES	NON- WiFi

CONTROL ACCESORIES - 6 SPEED DC MOTOR FANS

980014FWH-R - HIRO 6 Speed Remote Control (Transmitter Only)		
	AVAILABLE FINISHES	WH - White (shown)
	TYPE / FUNCTION	Fan / Light 6 Speed
	AMPS	—
	DIMMING	—
	NOTES	TRANSMITTER ONLY

980003FWH - 6 Speed Remote Control (Transmitter Only)		
	AVAILABLE FINISHES	WH - White (shown)
	TYPE / FUNCTION	Fan / Light 6 Speed
	AMPS	—
	DIMMING	—
	NOTES	TRANSMITTER ONLY

980013FAS - 6 Speed Wall Control (Transmitter Only)		
	AVAILABLE FINISHES	AS - White (shown)
	TYPE / FUNCTION	Fan / Light 6 Speed
	AMPS	—
	DIMMING	—
	NOTES	TRANSMITTER ONLY

CONTROL ACCESORIES - 4 SPEED DC MOTOR FANS

980001FXX - Wall Control 4 Speed DC (Transmitter Only)		
	AVAILABLE FINISHES	WH - White (shown) AL - Almond
	TYPE / FUNCTION	Fan / Light 4 Speed
	AMPS	—
	DIMMING	—
	NOTES	TRANSMITTER ONLY

CONTROL ACCESORIES - 3 SPEED AC MOTOR FANS

980014FWH - HIRO 3 Speed Remote Wall Control (Transmitter Only)		
	AVAILABLE FINISHES	WH - White (shown)
	TYPE / FUNCTION	Fan / Light 3 Speed
	AMPS	—
	DIMMING	—
	NOTES	TRANSMITTER ONLY

980030FWH - Wall Control 3 Speed (Transmitter Only)		
	AVAILABLE FINISHES	WH - White (shown)
	TYPE / FUNCTION	Fan / Light 3 Speed
	AMPS	—
	DIMMING	—
	NOTES	TRANSMITTER ONLY

INDEX

930003	144	900956FBN-NWA	39	902152FGT-LWD	79
931001	144	900956FMB-NWA	38	902152FMB-LWD	79
990012	146	900956FMM-NWA	39	902152FMM-LWD	79
990018	146	900956FMW-NWA	39	902152FMW-LWD	79
990024	146	900972FBN-NWA	41	902352FBN-LWA	89
990036	146	900972FMB-NWA	40	902352FMB-LWA	88
990048	146	900972FMM-NWA	41	902352FMM-LWA	89
990060	146	900972FMW-NWA	41	902352FMW-LWA	89
990072	146	900982FBN-LDD	46	902466FBN-LWD	77
991001	146	900982FMB-LDD	47	902466FGT-LWD	77
992001	146	900982FMM-LDD	47	902466FMB-LWD	76
900160FBN-LWD	82	900982FMW-LDD	47	902466FMM-LWD	77
900160FGT-LWD	83	900999FBN-LDD	49	902466FMW-LWD	77
900160FMM-LWD	83	900999FMB-LDD	49	902552FBN-LWD	81
900160FMW-LWD	83	900999FMM-LDD	48	902552FGT-LWD	81
900172FBN-LWD	84	900999FMW-LDD	49	902552FMB-LWD	80
900172FGT-LWD	85	901058FBN-NDD	43	902552FMM-LWD	81
900172FMM-LWD	85	901058FMB-NDD	43	902552FMW-LWD	81
900172FMW-LWD	85	901058FMM-NDD	42	902744FBN-LWD	92
900260FAW-NWA	90	901058FMW-NDD	43	902744FMM-LWD	93
900260FBN-NWA	91	901072FBN-NDD	45	902744FMW-LWD	93
900260FMM-NWA	91	901072FMB-NDD	45	902752FBN-LWD	94
900360FHB-LDD	26	901072FMM-NDD	44	902752FMM-LWD	95
900360FMM-LDD	27	901072FMW-NDD	45	902752FMW-LWD	95
900360FMW-LDD	27	901652FAW-NWA	123	902844FMM-LIA	97
900752FBN-LWD	67	901652FBN-NWA	123	902844FMW-LIA	96
900752FGT-LWD	67	901652FCW-NWA	122	902844FPW-LIA	97
900752FMB-LWD	67	901652FGT-NWA	123	902852FMM-LIA	99
900752FMW-LWD	67	901652FMB-NWA	123	902852FMW-LIA	98
900752FWK-LWD	66	901652FMM-NWA	123	902852FPW-LIA	99
900760FBN-LWD	69	901660FBN-NWA	125	902928FMB-LWD	111
900760FGT-LWD	69	901660FCW-NWA	124	902928FMM-LWD	110
900760FMB-LWD	68	901660FGT-NWA	125	902928FMW-LWD	111
900760FMW-LWD	69	901660FMB-NWA	125	903056FBN-LID	34
900760FWK-LWD	69	901660FMM-NWA	125	903056FHB-LID	35
900852FBN-LWD	71	901836FAW-NWA	137	903056FMM-LID	35
900852FGT-LWD	71	901836FBN-NWA	136	903160FMB-LDD	32
900852FMB-LWD	71	901836FMB-NWA	137	903160FMM-NDD	33
900852FMW-LWD	70	901836FMM-NWA	137	903160FMW-NDD	33
900860FBN-LWD	72	901952FGT-NWD	101	903254FHB-LID	36
900860FGT-LWD	73	901952FMB-NWD	101	903254FMB-LID	37
900860FMB-LWD	73	901952FMM-NWD	101	903254FMM-LID	37
900860FMW-LWD	73	901952FMW-NWD	100	903254FPW-LID	37
900872FBN-LWD	75	902054FAW-LWA	86	903352FBN-LIA	139
900872FGT-LWD	75	902054FBN-LWA	87	903352FBN-NIA	141
900872FMB-LWD	75	902054FMB-LWA	87	903352FBN-NWA	143
900872FMM-LWD	74	902054FMM-LWA	87	903352FCW-LIA	138
900872FMW-LWD	75	902152FBN-LWD	78	903352FCW-NIA	140

903352FCW-NWA	142	904152FCW-LIA	127	932028	145
903352FMB-LIA	139	904152FCW-NIA	128	980003FWH	149
903352FMB-NIA	141	904152FCW-NWA	131	980001FAL	145
903352FMB-NWA	143	904152FMB-LIA	127	980001FWH	145
903352FMM-LIA	139	904152FMB-NIA	129	980008	148
903352FMM-NIA	141	904152FMB-NWA	131	980009FWH	148
903352FMM-NWA	143	904152FMM-LIA	127	980010FAW	148
903460FMB-NDD	65	904152FMM-NIA	128	980011	148
903460FMM-NDD	65	904152FMM-NWA	130	980012FWH	148
903460FMW-NDD	64	904160FBN-NIA	132	980013FAS	149
903552FCW-LIA	121	904160FBN-NWA	135	980014FWH	17
903552FMB-LIA	121	904160FCW-NIA	133	980014FWH-R	17
903552FMM-LIA	120	904160FCW-NWA	135	980016FWH-019	101
903552FSS-LIA	121	904160FMB-NIA	133	980018FWH-035	121
903660FGT-LDD	50	904160FMB-NWA	134	980018FWH-0095	39
903660FMB-LDD	51	904160FMM-NIA	133	980018FWH-0097	41
903680FGT-LDD	52	904160FMM-NWA	135	980018FWH-016	123
903680FMB-LDD	53	904260FCW-LWD	28	980018FWH-0166	125
903744FGT-NDD	54	904260FMB-LWD	29	980018FWH-018	137
903744FMB-NDD	55	904260FMM-LWD	29	980018FWH-033	139
903744FMW-NDD	55	904280FCW-LWD	31	980018FWH-033L	139
903752FGT-NDD	57	904280FMB-LWD	31	980018FWH-0404	115
903752FMB-NDD	57	904280FMM-LWD	30	980018FWH-0405	117
903752FMW-NDD	56	904627FBN-LIA	104	980018FWH-0406	119
903760FGT-NDD	58	904627FHB-LIA	104	980018FWH-0415	129
903760FMB-NDD	59	904627FMB-LIA	105	980018FWH-415L	127
903760FMW-NDD	59	904724FMB-LIA	108	980018FWH-415W	131
903860FGT-NDD	60	904730FMB-LIA	109	980018FWH-416W	131
903860FMB-NDD	61	905022FBN-LIA	107	980030FWH	149
903880FGT-NDD	62	905022FHB-LIA	106	980040FWH	148
903880FMB-NDD	63	905022FMB-LIA	107	980045FWH	148
904042FBN-LIA	115	910452FAW	145	CNW900260	91
904042FCW-LIA	115	910452FDR	145	CNW902054	87
904042FMB-LIA	114	910452FMH	145	CNW902352	89
904042FMM-LIA	115	910452FWW	145	CNW902844	97
904052FBN-LIA	117	930001	144	CNW902852	99
904052FCW-LIA	117	930004	144	CNW904627	105
904052FHB-LIA	116	930005FAW-AM	144	CNW904724	109
904052FMB-LIA	117	930005FAW-WF	144	CNW904730	109
904052FMM-LIA	117	930006	144	CNW905022	107
904060FBN-LIA	118	930007	144		
904060FCW-LIA	119	930008	144		
904060FMB-LIA	119	932001	145		
904060FMM-LIA	119	932007	145		
904152FBN-LIA	126	932014	145		
904152FBN-NIA	129	932020	145		
904152FBN-NWA	131	932023	145		
904152FMM-LIA	127	932027	145		



We want you to enjoy your experience with Hinkley.

We're proud to be a 4th generation family company, and we love what we do. We've been designing and creating products with the same level of style and quality we put in our own homes since 1922. So whether you are flipping through our catalog, surfing our site, getting inspired through social media, chatting with a member of our team or checking out our designs with one of our retailers, we're always looking for your experience with Hinkley to be a positive one. Here's all you need to know:

CATALOG COLLECTIONS

Hinkley catalogs feature our current and complete product line along with important product specs and detailed photography. A must for the print-loving researcher who likes to tab their favorites. Stop by your local showroom for your own copy.

HINKLEY.COM

Dive in! Our easy-to-use site makes your product research process a snap, with the added benefit of tips, trends, installation guidelines and a quick connection to our retail partners.

SOCIAL CLIMBERS

We don't mean to brag, but we are connected.



REAL PEOPLE

Want to chat? Contact us at service@hinkley.com or 1.800.HINKLEY.

Hinkley stands behind the quality of our fixtures with product warranties that are among the strongest in the industry. For details of warranty coverage on specific products, please refer to hinkley.com or consult a qualified Hinkley retail distributor.

Several Hinkley products are protected under U.S. Patent and foreign patent, or patent pending. For current information regarding Hinkley's patent portfolio, please visit hinkley.com.

©2022 Hinkley, Inc. All rights reserved in all copyrightable works.

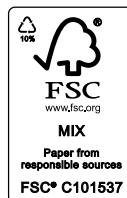

Hinkley is a proud partner of the American Lighting Association.

HINKLEY

HINKLEY.COM

GLOBAL HEADQUARTERS

33000 Pin Oak Parkway | Avon Lake, Ohio 44012

T 440 653 5500 | F 440 653 5555 | hinkley.com

SHOWROOM

Dallas Trade Mart 3210 | Dallas, Texas 75207

High Point Market MS290 | High Point, North Carolina 2726



Connect with us | [#hinkleystyle](https://www.instagram.com/hinkleystyle)

2022 FAN
CATALOG

FAN2022

